

Panasonic®

Multi Format Digital HD Video Cassette Recorder Operating Instructions (Software)

Model No. AJ-HD3700B_{PE}

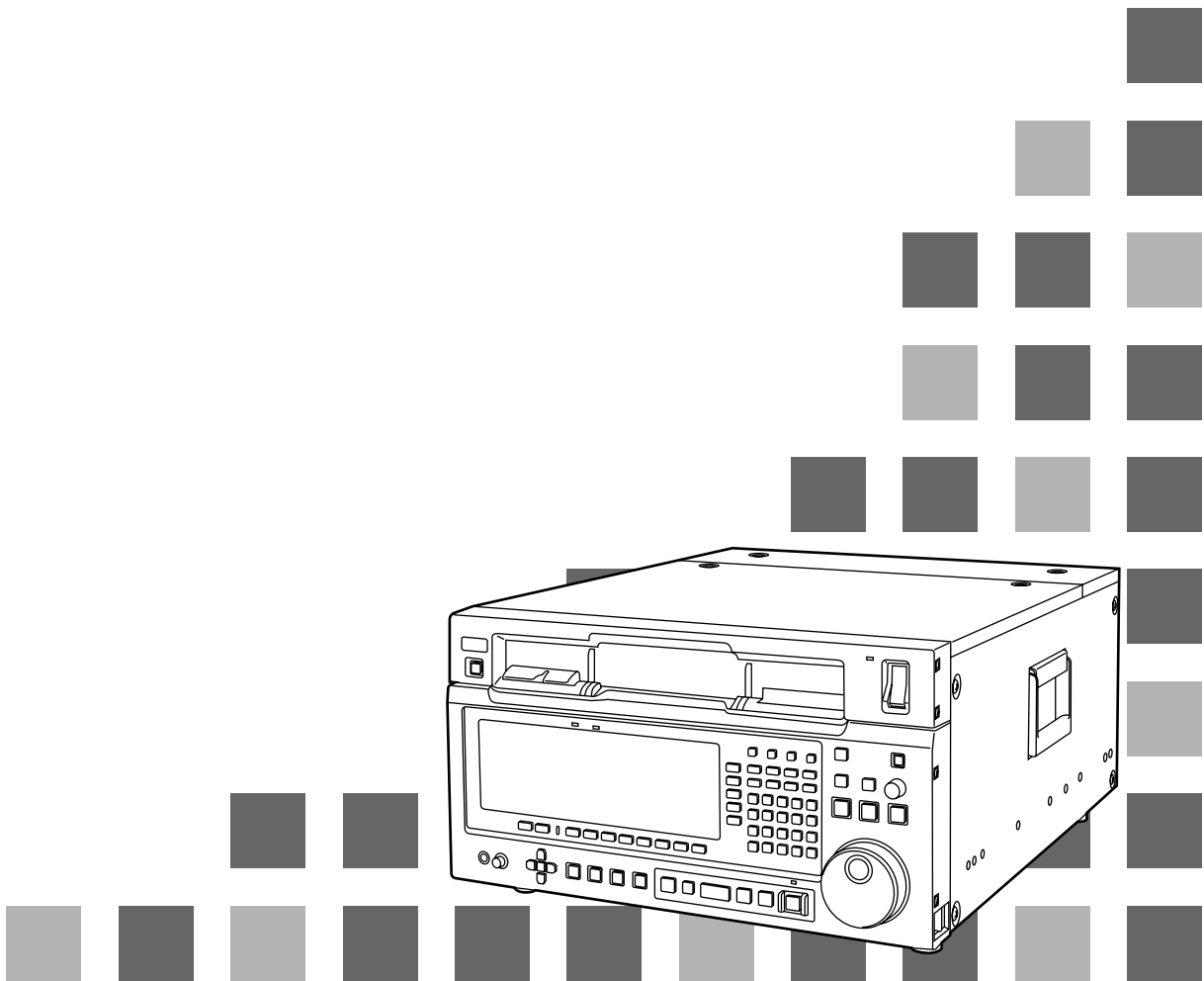

Before operating this product, please read the instructions carefully and save this manual for future use.

Contents

| | | | |
|--|----|---|-----|
| Menu screen transitions | 4 | AUDIO IN CUE INPUT SELECT menu | 53 |
| Turning on the power | 7 | AUDIO IN SET UP menu | 55 |
| HOME menu displays | 8 | AUDIO IN CH-MIX SELECT menu | 58 |
| HOME menu | 13 | AUDIO OUT menu | 61 |
| HOME SET UP menu | 17 | AUDIO OUT MONITOR menu | 63 |
| VIDEO IN menu | 22 | AUDIO OUT SET UP menu | 65 |
| VIDEO OUT HD menu | 24 | AUDIO OUT SET UP STATE menu | 70 |
| VIDEO OUT HD SET UP menu | 26 | AUDIO OUT SDI ASIGN menu | 72 |
| VIDEO OUT HD SET UP STATE menu | 28 | TC/CHR menu | 75 |
| VIDEO OUT SD menu | 30 | TC/CHR SET UP menu | 81 |
| VIDEO OUT SD SET UP COMPOSITE menu | 32 | TC/CHR SET UP VITC.L menu | 83 |
| VIDEO OUT SD SET UP CMPST STATE menu | 34 | TC/CHR CONVERT menu | 85 |
| VIDEO OUT SD SET UP SDI menu | 36 | Audio insert editing function with 23.98 Hz VTR system and 30 Hz external operating environments | 88 |
| VIDEO OUT SET UP LINE BLK (video output line blanking) menu | 38 | LTC output selection when playing back a 25P (23.98P/24P) tape with a 23.98/24 (25) Hz VTR system added | 90 |
| VIDEO OUT SD SET UP SDI STATE menu | 40 | MULTI CUE menu | 91 |
| VIDEO OUT CONVERT menu | 42 | MULTI CUE SET UP menu | 95 |
| VIDEO OUT CONVERT HD_TO_SD menu | 43 | INSERT/ASSEMBLE MANUAL EDIT menu | 97 |
| VIDEO OUT CONVERT SD_TO_HD menu | 46 | INSERT/MANUAL EDIT CH SELECT menu | 98 |
| VIDEO OUT CONVERT HD_TO_HD menu | 47 | INSERT/ASSEMBLE MANUAL EDIT SET UP menu | 100 |
| AUDIO IN menu | 48 | INSERT/ASSEMBLE AUTO EDIT menu | 108 |
| AUDIO IN PCM INPUT SELECT menu | 50 | INSERT AUTO EDIT CH SELECT menu | 115 |
| | | INSERT/ASSEMBLE AUTO EDIT SET UP menu | 117 |

The underlining of functional description with each menu denotes the initial setting.

Contents

| | | | |
|--|-----|------------------------------------|-----|
| SET UP menu | 121 | TEST IC CARD ERROR LOG | |
| INTERFACE SET UP menu | 122 | menu | 175 |
| PANEL SET UP menu | 128 | TEST IC CARD ERROR LOG | |
| PANEL SET UP (OP MAP REMOTE) | | MONITOR menu | 176 |
| menu | 130 | Error messages | 177 |
| PANEL SET UP (OP MAP LOCAL) | | DIAG menu error messages | 178 |
| menu | 133 | DIAG ACTIVE menu | 179 |
| USER SET UP menu | 135 | DIAG MASKED menu | 180 |
| SYSTEM SET UP menu | 140 | DIAG LAST menu | 181 |
| ENGINEER SET UP menu | 146 | DIAG error messages | 182 |
| RF ENGINEER SET UP menu | 147 | AUTO OFF error messages | 186 |
| OPERATION ENGINEER SET UP | | SYSTEM error messages | 188 |
| menu | 149 | Operation messages | 190 |
| TEST menu | 151 | Operation messages (in AUTO EDIT | |
| RF TEST menu | 153 | mode) | 191 |
| RF adjustment value display menu | 156 | Screen saver function | 192 |
| AUDIO TEST menu | 157 | | |
| MECHA TEST menu | 158 | | |
| SYSTEM TEST menu | 160 | | |
| SERVO TEST menu | 161 | | |
| TEST FRONT menu | 164 | | |
| TEST FRONT PANEL menu | 165 | | |
| TEST FRONT KEY CHECK IN menu | 166 | | |
| Inserting the IC card | 168 | | |
| TEST IC CARD menu | 169 | | |
| TEST IC CARD USER menu | 171 | | |
| TEST IC CARD MULTI CUE menu | 172 | | |
| TEST IC CARD MULTI CUE SELECT | | | |
| menu | 173 | | |
| TEST IC CARD MULTI CUE MONITOR | | | |
| menu | 174 | | |

Menu screen transitions

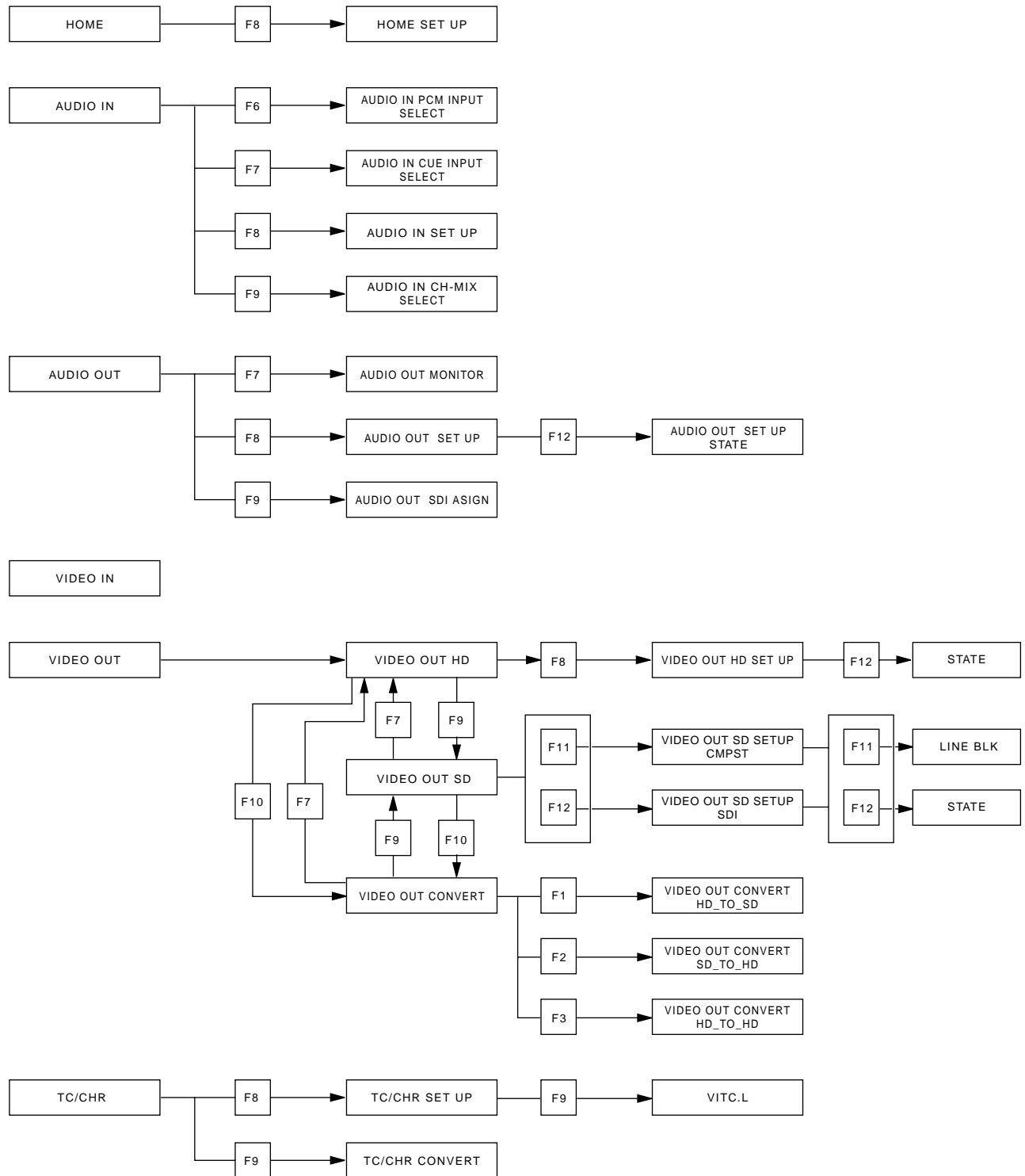

Menu screen transitions

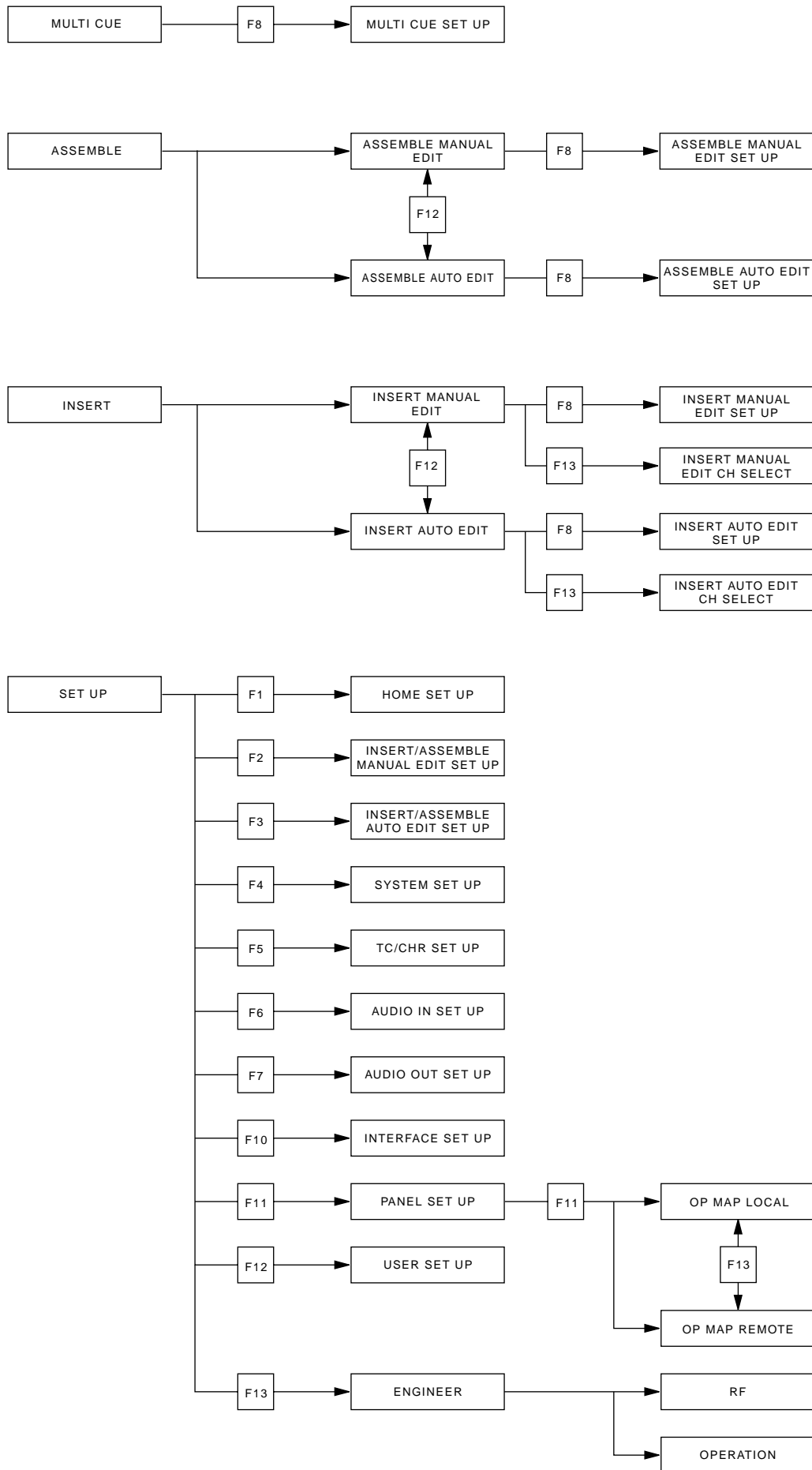

Menu screen transitions

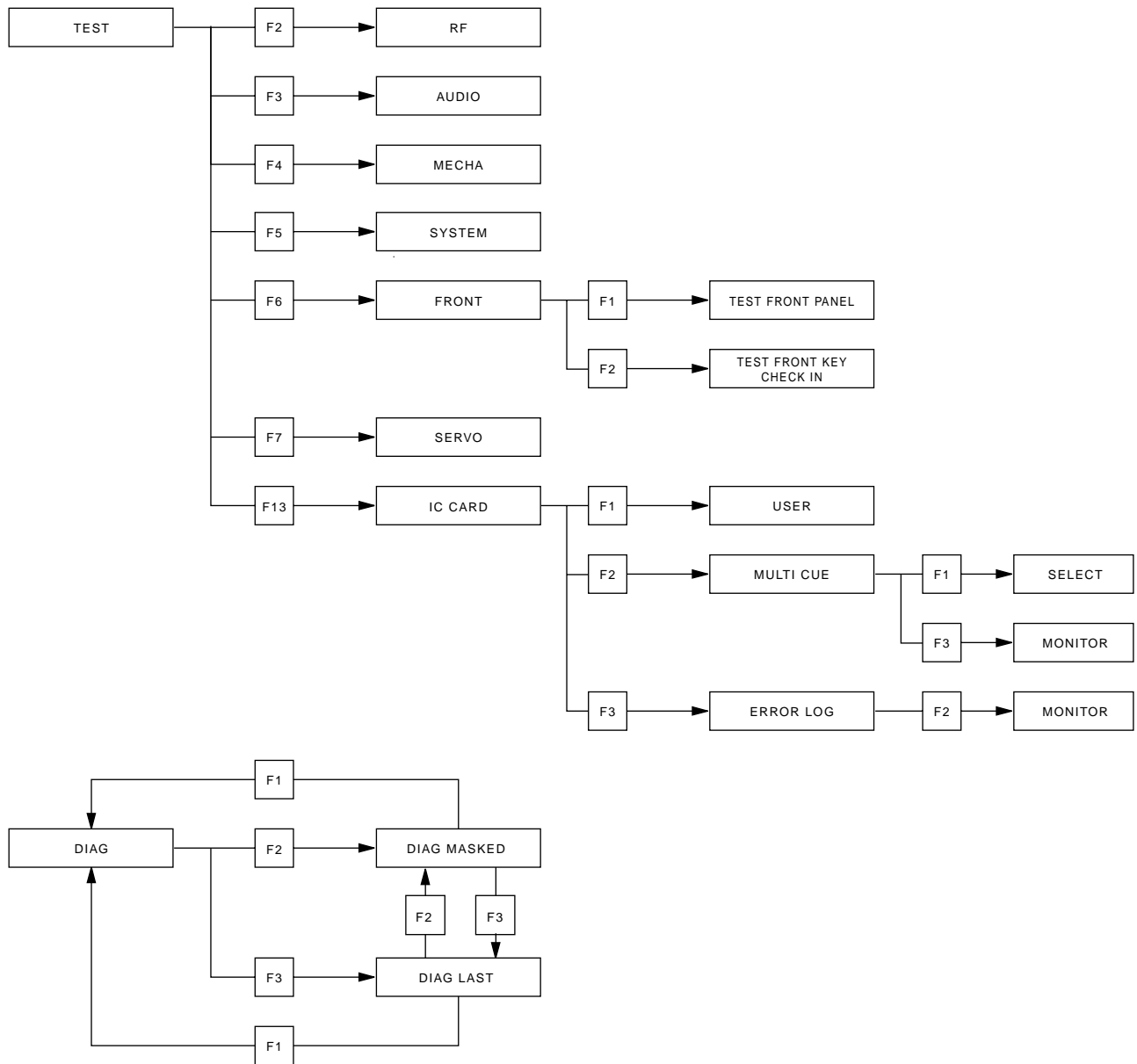

Turning on the power

Turn on the power.

▼
The HOME menu is displayed.

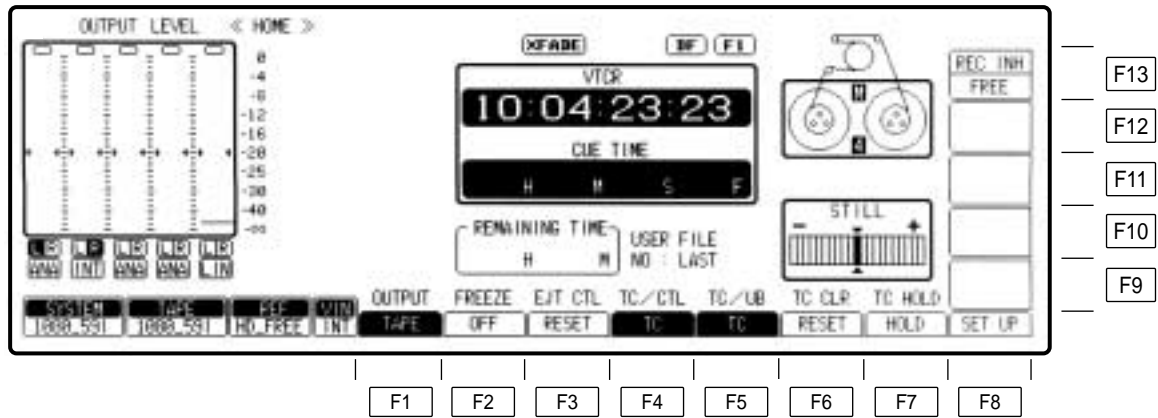

This VTR comes already programmed with menus that correspond to specific operating objectives, and the operations performed on each differ from one menu to another. When a menu is selected using a menu selection button, what appears on the display changes, and the function keys (F1 to F13) also implement the function corresponding to the respective menu items.

SET UP menus are provided in order for the user to have settings on hand for the seldom used functions, etc. among the various menu items.

The HOME menu is provided as the VTR's basic menu. It automatically appears on the display when the power has been turned on. (However, the IC CARD menu will automatically appear if an IC card has been inserted.)

<Note>

The animation display of a cassette tape appears after the cassette tape has been inserted.

HOME menu displays

□ **Audio signal display area** (Either 8 or 4 channels will be automatically displayed depending on the format used.)

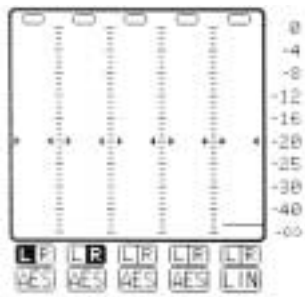

- Use this to adjust the level of the input audio signals on the AUDIO IN menu. Alternatively, it is used to adjust the level of the audio playback output signals on the AUDIO OUT menu.
- Press the L/R buttons to select the audio channel whose signals are to be output from the AUDIO MONITOR L/R connectors and HEADPHONES jack.
- These display the type of input signals of each channel. The F1 (CH-1) to F6 (DIGITAL) [or F1 (CH-1) to F13 (CH-8) for 8 channels] on the AUDIO IN PCM INPUT SELECT menu are selected using the F9 (CH-MIX) key on the AUDIO IN CUE INPUT SELECT menu.

- ┌ **ANA:** Signals from the ANALOG INPUT connectors.
- ┌ **CH1 AES:** Signals from the DIGITAL AUDIO INPUT connectors.
- └
- ┌ **CH1 SER:** Signals from the serial V/A input connectors.
- └ **INT:** Signals from the internal signal generator.
- ┌ **LINE:** Signals from the CUE IN connector.
- ┌ **CUE MIX:** CH1 to CH8 signals selected by CUE MIX setting.
- └ **AUTO:** This is always used for digital channel backup purposes.

□ **Display lamps**



- SYSTEM:** This indicates the video system format which was set on the SETUP/SYSTEM menu.
1080_59i, 525_59i, 1080_23psf, 1080_23p, 1080_24psf, 1080_24p, 720_59p, 1080_50i, 1080_25p, 625_50i
- TAPE:** This indicates the format of the playback tape.
“*****” appears in the EJECT mode.
If a section is unrecorded or if the format of a section cannot be identified, the lamp blinks while the display of the format identified up to the section concerned is retained.
1080_59i, 1080_60i, 1035_59i, 1035_60i, 525_59i, 1080_23p, 1080_24p, 720_59p, 720_60p, 1080_50i, 1080_25p, 625_50i

<Note>

A tape recorded with the system format set to 1080/23.98psf or 1080/23.98p is recorded in the same tape format, and “1080_23p” is displayed on the front panel when it is played back. Similarly, “1080_24p” appears on the front panel with a tape recorded using the 1080/24psf or 1080/24p system, and “1080_25p” appears when a tape recorded using the 1080/25psf or 1080/25p system.

How to display the menus:

- AUDIO IN menu: AUDIO IN
- AUDIO OUT menu: AUDIO OUT
- AUDIO IN PCM INPUT SELECT menu: AUDIO IN → F6
- AUDIO IN CUE INPUT SELECT menu: AUDIO OUT → F7

HOME menu displays



REF: This indicates the status of the output reference signal which has been selected by the VTR.

HD REF59: HD REF with a field frequency of 59.94 Hz is selected.

HD REF47: HD REF with a field frequency of 47.96 Hz is selected.

HD REF48: HD REF with a field frequency of 48.00 Hz is selected.

HD REF50: HD REF with a field frequency of 50.00 Hz is selected.

SD REF59: The NTSC signal is selected as the SD REF signal.

SD REF50: The PAL signal is selected as the SD REF signal.

HD IN59: The HD serial input with a frame frequency of 29.97 Hz is selected as the REF signal.

HD IN47: The HD serial input with a frame frequency of 23.98 Hz is selected as the REF signal.

HD IN48: The HD serial input with a frame frequency of 24.00 Hz is selected as the REF signal.

HD IN50: The HD serial input with a frame frequency of 25.00 Hz is selected.

SD IN59: The SD serial input with a field frequency of 59.94 Hz is selected.

SD IN50: The SD serial input with a field frequency of 50.00 Hz is selected.

HD FREE: The HD internal signal generator is used since no REF signal has been selected using the OUT REF setting.

SD FREE: The SD internal signal generator is used since no REF signal has been selected using the OUT REF setting.

*DUAL: HD REF47 and SD REF59 have been selected simultaneously.

This setting takes effect when 1080/23psf has been selected as the VTR's system format, AUTO has been selected by the OUT REF setting, and two of the above REF signals have been input.

*This VTR uses the HD REF and SD REF signals as a reference for entering the 24 → 60 conversion inside the unit.

HOME menu displays

□ Setting mode display area



← The displays appearing in this area indicate the modes which have been set.

CUT: Appears when the audio cut editing mode is set.
XFADE: Appears when the audio cross-fade editing mode is set.

VFADE: Appears when the audio V fade editing mode is set.

INTRP: Appears when the time code interpolation mode (in which the time code cannot be read out accurately) is established.

DF: Appears when the drop frame mode is set.

F1/F2: Indicates the field numbers for VITC.

EMPHASIS: Appears when pre-emphasis is applied to the audio signals.

TRACK VAR: Appears when an adjustment has been made with the tracking deviated from the fixed position.

TRACK OPT: Appears when an optimizing adjustment has been made for the tracking.

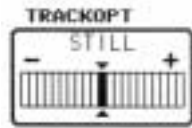

□ Remaining tape time

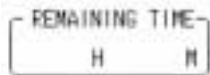

This indicates the remaining tape time as the tape travels.

□ User file display



This indicates the number of file which is called when the power is switched on or the currently called user file. If there is a discrepancy between the contents of the user file displays and even one current setting, “*” will appear in front of the file number.

□ Time code displays



← These indicate the time code values.

CTL1: Normal control signal

CTL2: Control signal (which cannot be reset)

LTCR: LTC readout

LUBR: LTC user bit readout

VTOR: VITC readout

VUBR: VITC user bit readout

TCG: Value generated by generator

LUBG: Value of LTC user bit generated

VUBG: Value of VITC user bit generated

E-TC: External time code

E-UB: External user bit

□ Checking the value generated by generator

INPUT CHECK



Press the INPUT CHECK key. While the key is held down, the value generated by the generator is displayed.

TCG



HOME menu displays

□ Setting the initial value for the time code

- (1) Press the center cursor key.
The display now appears in reverse video.



- (2) Press the center cursor key again so that the cursor is made to serve as a column cursor, and then use the number key to input the value.

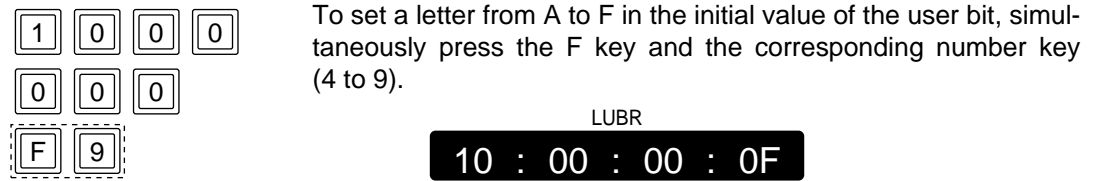

- (3) Press the ENT key.
The cursor is now cleared. (This completes the setting of the initial value.)

- To clear the value entered, press the C key in step (2).
- To check the value which has been input, press the INPUT CHECK key.

HOME menu displays

□ Setting and checking the cue time

- (1) Press the center cursor key.
The time code display now appears in reverse video.



- (2) Press the [▼] cursor key.
The cue time now appears in reverse video.

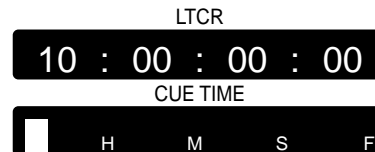

- (3) Press the center cursor key again so that the cursor is made to serve as a column cursor, and then use the number keys to input the value.



- (4) Press the ENT key.
The cursor is now cleared. (This completes the setting of the cue time.)
- (5) Press the PREROLL button.
The cue time on the tape is searched, and the tape is prerolled for the cue time, after which it stops.

- When the ENTRY button is pressed, the tape's current position is automatically input.
- Pressing the F key and PREROLL button at the same time in step (5) initiates the search operation, and the tape stops at the entered cue point.

HOME menu

This menu is displayed by pressing the following key: HOME

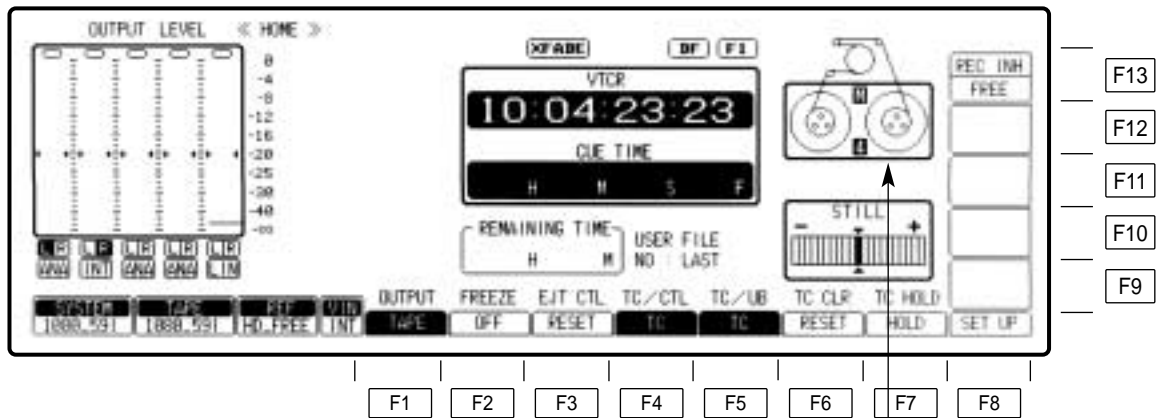

4: Cassette tape in the 4-channel audio format.

8: Cassette tape in the 8-channel audio format.

(This display indicates the C bit pin position of the cassette tape.)

If system format does not matched with the C bit pin position of the cassette tape, 4 or 8 display will flash to warn its miss-matching.

HOME menu

| Key | Key designation | Description |
|-----|--|---|
| F1 | OUTPUT For selecting the audio/video output signals. | The mode opposite to the current one is established only while this key is held down. (When the key is pressed during TAPE setting, the EE mode is established.) (If this key is pressed together with the F key, the display switches.) TAPE: Outputs playback signal. EE: Outputs the EE system signals. ●Valid only in STOP, REC or EJECT mode. Invalid during playback. ●This key does not operate during CUE signal output. |
| F2 | FREEZE For outputting the flash freeze frame. | Outputs field memory 1 screen continuously. Flash freeze frame is assumed only while this key is pressed. If this key is pressed together with the F key, the setting can be fixed. ON: Output field memory screens. OFF: No freeze-framing. |
| F3 | EJT CTL For CTL operation in EJECT mode. | RESET: Resets CTL1 when cassette is ejected. Resets CTL2 when cassette is loaded. HOLD: Holds CTL values for both CTL1 and CTL2 when cassette is ejected. |
| F4 | TC/CTL For timer mode switching. | TC: Displays the time code. CTL1: Displays the control signal value. (This can be reset to zero.) CTL2: Automatically resets the control signal value to zero when the cassette tape is loaded. The control signal value cannot be reset after this. |
| F5 | TC/UB For switching the display between the TC and UB values. | TC: Displays the TC value. UB: Displays the UB value. ●Valid only when [TC] is selected with F4 key. ●Displays the time code readout value during playback. ●Displays the time code value recorded on tape during recording. To display values generated at times other than recording, press the INPUT CHECK key. |
| F6 | TC CLR For clearing the TC value. (TCG CLR) For clearing the UBG value. (UB CLR) For clearing the UB value. | Valid only when the TC/CTL key is set to CTL1. RESET: CTL1 time data is reset to zero. Valid only when the TC/CTL key and the TC/UB key are set to TC. RESET: TCG value is reset to zero when F key is simultaneously pressed. Valid only when the TC/CTL key is set to TC and the TC/UB key is set to UB. RESET: UBG value is reset to zero when F key is simultaneously pressed. However, since there are two UBG values, VITC UBG and LTC UBG, they are supported as follows by the TCR settings on the TC/CHR menu. TCR: AUTO Both VITC UBG and LTC UBG are reset to zero. TCR: LTC LTC UBG is reset to zero. TCR: VITC VITC UBG is reset to zero. |
| F7 | TC HOLD For holding the TC value on the display. | Continues to display the time code data which was displayed when the key was pressed. ●Press again to release the hold value. |

HOME menu

| Key | Key designation | Description |
|--------|---|--|
| F8 | SET UP | Transfers the VTR to the HOME SET UP menu screen. |
| F9–F10 | — | |
| F11 | PREAD A* For setting audio pre-read to ON or OFF (SD mode only) | This is used during insert editing in the AUTO or MANUAL EDIT mode when the already recorded digital signals are to be read in advance and used as the editing source. To set the item to ON, press the F together with the F11 or F12 key. To set it to OFF, press the F11 or F12 key on its own. When ON is selected as the setting, refer to the section on pre-read editing (next page). ON: The digital signals are read in advance (pre-read). OFF: The digital signals are not read in advance (pre-read). Simultaneous playback is possible during editing. ● If OFF is selected by the F11 or F12 key, vibration may occur when EE has been selected on the STATE screen. (This happens only when the input and output of the same channel have been connected.) ● If ON has been set for either of these items, the up-converter picture will be muted. |
| F12 | PREAD V* For setting video pre-read to ON or OFF (SD mode only). | |
| F13 | REC INH For setting the record inhibit mode. | FREE: Enables recording. NRML.REC: Prohibits normal recording; enables editing. (The REC INHIBIT lamp blinks at long intervals.) ALL: Prohibits all recording. (REC INHIBIT lamp glows.) ● The CASSETTE REC INHIBIT mode which is set using the recording inhibit pins on the cassette tape takes precedence over this key's setting. |

*The above functions can be set only when the 480/59.94i or 567/50i system format is selected.

HOME menu

□ Pre-read editing [Performed in the SD mode (480/59i or 576/50i) only.]

- (1) Set the pre-read function to ON by pressing the F key and F11 key (PREAD A) or F12 key (PREAD V) together.

| |
|---------|
| PREAD V |
| ON |
| PREAD A |
| ON |

- (2) Perform the connections for pre-read editing as shown in the figure below.
- (3) Proceed with pre-read editing in the desired insert editing mode.
- (4) Restore the original connections upon completion of the editing.
- (5) Press the F11 or F12 key to set the pre-read function to OFF.
- (6) Check that there are no loop connections.

<Note>

During pre-read operations, the SD SDI MONITOR and AUDIO MONITOR connectors function as monitoring connectors, and the input signals are output from the IN point to the OUT point in their original state.

Further, the preread monitor function will not work when the monitor MIX function has been set to ON. To use the function, set MIX to OFF.

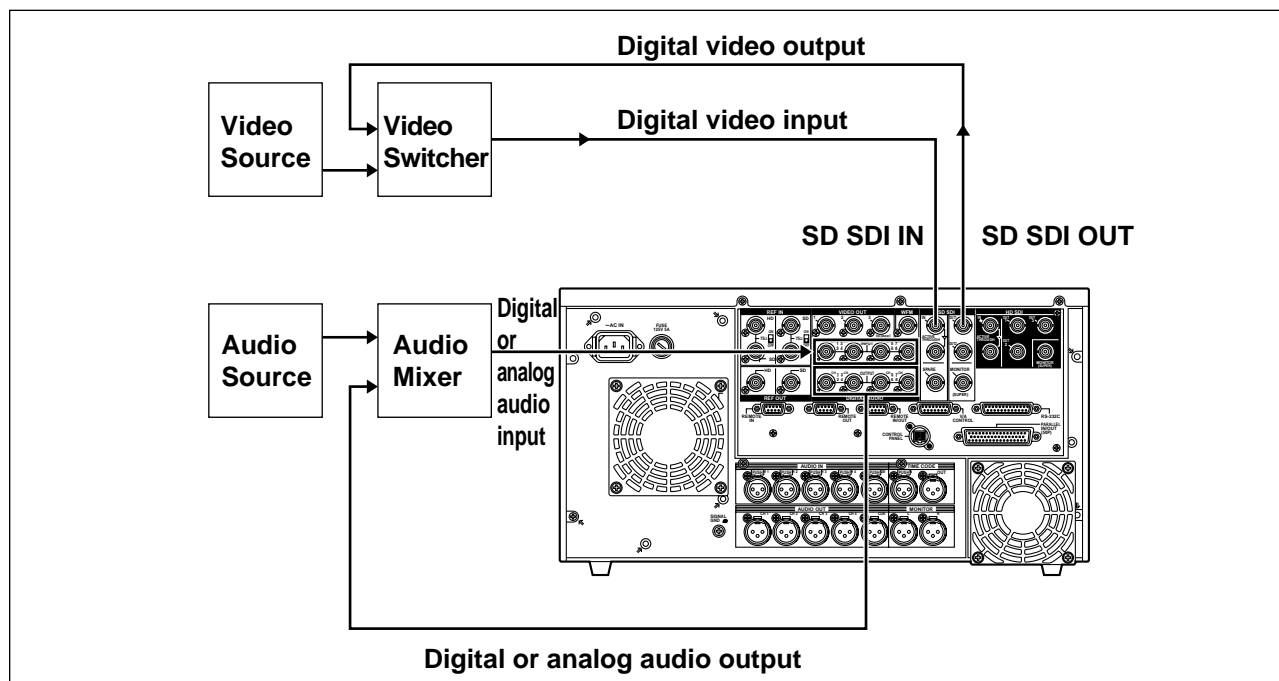

Connections for pre-read editing

HOME SET UP menu

This menu is displayed by pressing the following keys: **HOME** → **F8**
 OR
SET UP → **F1**

The screenshot shows the 'HOME SET UP' menu with various settings and function key callouts:

- OUTPUT LEVEL:** A vertical scale from 0 to -40 dB with a bar graph.
- REFERENCE:** A sub-menu with options: OUT REF: **AUTO** | INPUT | HD REF | SD REF.
- REC INHIBIT:** A menu with options: CASSETTE, FREE, VID./CNTL, ALL.
- STBY OFF:** A menu with options: 3MIN, STILL, 1MIN, PREROLL, 5SEC.
- STILL:** A horizontal bar graph with a central marker.
- STATUS BAR:**
 - SYSTEM: 1080i 23.976
 - TAP: *****
 - REF: HD FREE
 - MIN: DIC
 - SYNC PLY AT PLAY: OFF
 - PRG PLY: FIELD
 - PRG PLY: FINE
 - CAP LOCK: 0.0%
 - TAPE NO: BF AUTO
 - HD STOP
 - EXIT
- Function Key Callouts (F9-F13):**
 - F13:** Points to the STBY OFF menu.
 - F12:** Points to the STILL option in the STBY OFF menu.
 - F11:** Points to the PREROLL option in the STBY OFF menu.
 - F10:** Points to the STILL bar graph.
 - F9:** Points to the EXIT option in the status bar.

HOME SET UP menu

| Key | Key designation | Description |
|-----|--|---|
| F1 | SYNC PLY Sync play. | Automatically compensates for the start initiated for the playback mode. For instance, when the VTR is set to the playback mode from the preroll point, it synchronizes its own phase to ensure that the tape arrives at the IN point after the preroll time has elapsed. (The function takes effect only when the front panel controls are used for operation.) ON: Sync play function operates. OFF: Normal playback is assumed. |
| F2 | AT PLY For switching the playback picture in JOG/VAR. | FIELD: Plays the tape field by field. FRAME1/ FRAME2*1: Plays back on a frame by frame basis at the –1a to +1a speed and on a field by field basis at all other speeds. If the tape material image has a scene cutoff when moving from No. 2 field to No. 1 field, as when editing with the No. 1 field as cutoff, use FRAME 1. Use Frame 2 when the No. 2 field is the scene cutoff. |
| F3 | PRG PLAY Program play. | Selects the variable step for program play. FINE: 0.1% step COARSE: 1.0% step |
| F4 | PRG PLAY Program play. | Normal playback occurs at variable speed within the range of $\pm 5\%$ with the variable step of the F3 key. (Initial setting is 0.0%) Refer to “Programmed play function”. |
| F5 | CAP LOCK*2 For setting the capstan servo lock | Selects the capstan servo lock mode during playback. 4F AUTO (8F AUTO: 1080/23p, 1080/24p, 1080/50i, 576/50i): Assumes color frame auto lock mode. If there is any discontinuity in the color frame during playback, the unit locks again at a new color frame. 4F FORCE (8F FORCE: 1080/23p, 1080/24p, 1080/50i, 576/50i): Assumes color frame forced lock mode. If there is any discontinuity in the color frame during playback, the unit preserves the field sequence at initial lock. 2F: Assumes frame lock mode. ●The capstan servo lock mode can be set in AUTO (or MANUAL) EDIT SET UP menu. If the two settings differ, priority is given to the final mode setting. |
| F6 | TAPE MD. Tape mode when the VTR is in standby OFF. | HD.STOP: Stops the drum when the tape is loose. HLF LOAD: Half-loads the tape. |
| F7 | — | |
| F8 | EXIT | Returns the VTR to the HOME menu screen. |

*1 This item does not function when the 720/59p, 1080/23p, 1080/24p or 1080/25p format has been selected.

*2 <Note>

In the 1080/59i format, the factory setting for this item is 2F. In the 1080/23p format, it is 8F AUTO. The fact that the factory setting differs depending on the format should be borne in mind when one format is converted into another.

HOME SET UP menu

| Key | Key designation | Description |
|--------|---|---|
| F9–F10 | — | |
| F11 | PREROLL For selecting the preroll time. | After pressing the F11 key, turn the ADJUST control. Selection can be made between 0 and 30 seconds. (Initial setting is 5 seconds.) |
| F12 | STILL For setting the STOP/STILL (static frame) mode holding time. | Sets the stop/still (still picture) mode holding time. In order to protect the tape, the VTR is automatically transferred to the tape tension release mode (loosing) after a specific time has elapsed. This specific time can be set. After pressing the F12 key, turn the ADJUST control. 1 sec, 3 sec, 30 sec, <u>1 min</u> , 3 min or 5 min can be set as the holding time. When the stop/still mode holding time is set to 5 min, the STILL STEP ON/OFF function can be selected. For details, refer to F2 (STILL STEP) key of the OPERATION ENGINEER SET UP menu on page 145. |
| F13 | STBY OFF For setting the time for the transfer to standby OFF. | For setting the time for the transfer from tape loosing to standby OFF. After pressing the F13 key, turn the ADJUST control. 1 sec, 3 sec, 30 sec, 1 min, <u>3 min</u> , 16 min and ∞ [Infinity: No transfer to standby OFF mode (drum stop/half loading)] can be set. |

HOME SET UP menu

□ Reference

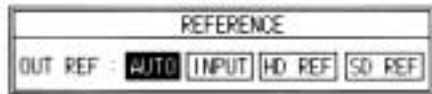

OUT REF: This sets the video output signal reference.

AUTO: When the REF VIDEO connector input signal is available, the output reference is locked to REF VIDEO; when it is not available, it is locked to the INPUT input signal. When neither the REF VIDEO nor INPUT input signal is available, the internal signal serves as the reference.

Depending on the format, the sequence of priority is as follows:

HD mode:

HD REF>SD REF>INPUT>FREE

SD mode:

SD REF>HD REF>INPUT>FREE

INPUT: When the INPUT input signal is available, the output reference is locked to the INPUT signal; when it is not available, the internal signal serves as the reference.

HD REF: When the HD REF input signal is available at the HD REF IN connector, the output reference is locked to the REF signal; when it is not available, the internal signal serves as the reference.

SD REF: When the SD REF input signal is available at the SD REF IN connector, the output reference is locked to the REF signal; when it is not available, the internal signal serves as the reference.

Operation

- (1) Press the center cursor key.
The cursor now appears.

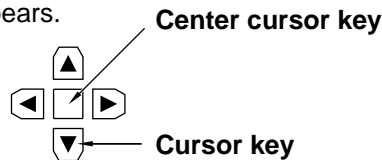

- (2) Move the cursor to the item to be set using the cursor keys.
The selected item now blinks.

OUT REF: INPUT

- (3) Press the ENT key. The setting is now entered.

*In the 720/59p mode, use the SD REF for synchronization with an external component. (In this mode, SD REF or SF FREE is used.)

When AUTO has been set, the sequence of priority is as follows: SD REF>FREE.

HOME SET UP menu

Programmed play function

- (1) Press the F4 (PRG PLY) key.
- (2) Set the step to FINE or COARSE using the F3 (PRG PLY) key.
- (3) Set the programmed play speed using the ADJUST control.

PRG PLY
2.0%

- (4) Press the PLAY and VAR buttons together.
- (5) To change the playback speed, turn the ADJUST control while pressing the VAR button.
- (6) To stop programmed play, press the STOP button.

VIDEO IN menu

This menu is displayed by pressing the following key: VIDEO IN

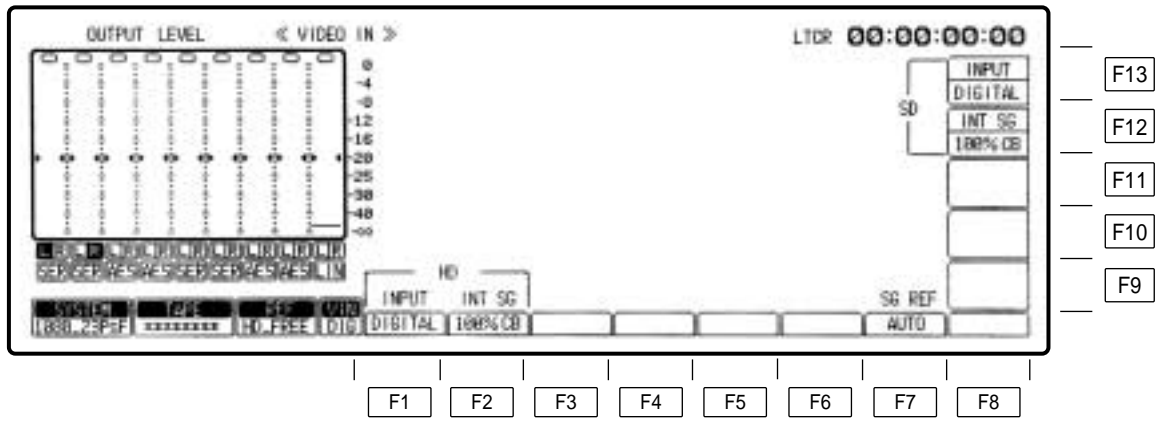

VIDEO IN menu

| Key | Key designation | Description |
|--------|--|--|
| F1 | INPUT For selecting the HD video input signals. | DIGITAL: Selects the serial input signals. INT SG: Selects the internal signals. |
| F2 | INT SG For selecting the type of HD internal signals. | 75% CB: Selects the 75% color bar signal. 100% CB: Selects the 100% color bar signal. RAMP: Selects the RAMP signal. MULT-BST: Selects the multi-burst signal. BLACK: Selects the black-burst signal. SIF PLL: Selects the signals for checking the serial interface PLL. SIF EQ: Selects the signal for checking the serial interface equalizer. SMPTE CB: Selects the SMPTE color bar signal. ARIB CB: Selects the ARIB color bar signal. |
| F3–F6 | — | |
| F7 | SG REF For synchronizing the INT SG | AUTO: When video input signals are present, the internal reference signal is locked to the input signals; when video input signals are not present, it is locked to the signal selected by the OUT REF setting*. OUTPUT: The internal reference signal is locked to the signal selected by the OUT REF setting*. <Note> Bear in mind that the embedded audio signal in the SD SDI input will be muted when OUTPUT is selected for this setting. |
| F8–F11 | — | |
| F12 | INT SG For selecting the type of SD internal signals. | 75% CB: Selects the 75% color bar signal. 100% CB: Selects the 100% color bar signal. RAMP: Selects the RAMP signal. MULT-BST: Selects the multi-burst signal. BLACK: Selects the black-burst signal. SIF PLL: Selects the signals for checking the serial interface PLL. SIF EQ: Selects the signal for checking the serial interface equalizer. SMPTE CB: Selects the SMPTE color bar signal. |
| F13 | INPUT For selecting the SD video input signals. | DIGITAL: Selects the serial input signals. INT SG: Selects the internal signals. |

*Refer to the HOME SET UP menu.

VIDEO OUT HD menu

This menu is displayed by pressing the following key: VIDEO OUT

The screenshot shows the 'VIDEO OUT HD' menu with the following elements:

- OUTPUT LEVEL** title and **< VIDEO OUT HD >** navigation text.
- LTCR 00:00:00:00** timecode display.
- Four vertical sliders for **Y**, **PB**, **PR**, and **BLACK L**, each with a scale from -60 to 0 dB or mV.
- A **CONVERT** button and a **50** value field.
- A **SET UP** button at the bottom right.
- Bottom status bar with labels: **1080i 25FPS ***** HD FREE DIG** and **UNITY UNITY UNITY UNITY**.
- Function key labels: **F1** through **F8** below the menu, and **F9**, **F10**, **F11**, **F12**, **F13** to the right of the menu.

VIDEO OUT HD menu

| Key | Key designation | Description |
|---------|---|--|
| F1 | For adjusting the Y level. | $-\infty$ to +3 dB (−3 dB to +3 dB in fine adjustment mode) ● Establishes the fine adjustment mode if the key is pressed together with the F key. |
| F2 | PB For adjusting the P _B level. | $-\infty$ to +3 dB (−3 dB to +3 dB in fine adjustment mode) ● Establishes the fine adjustment mode if the key is pressed together with the F key. |
| F3 | PR For adjusting the P _R level. | $-\infty$ to +3 dB (−3 dB to +3 dB in fine adjustment mode) ● Establishes the fine adjustment mode if the key is pressed together with the F key. |
| F4 | BLACK.L For adjusting the black level. | ± 100 mV |
| F5–F7 | — | |
| F8 | SET UP | Transfers the VTR to the VIDEO OUT HD SET UP menu screen. |
| F9 | SD | Transfers the VTR to the VIDEO OUT SD menu screen. |
| F10 | CONVERT | Transfers the VTR to the VIDEO OUT CONVERT menu screen. |
| F11–F13 | — | |

VIDEO OUT HD SET UP menu

This menu is displayed by pressing the following keys: VIDEO OUT → F8

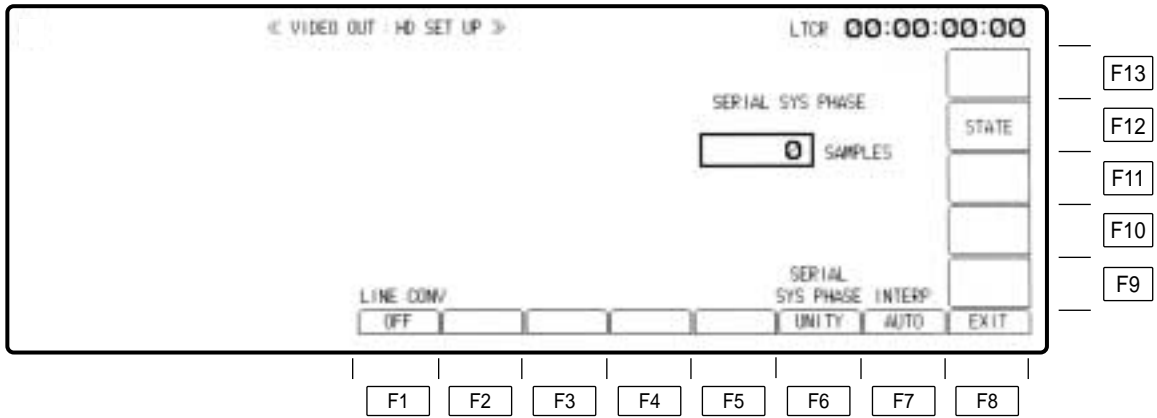

VIDEO OUT HD SET UP menu

| Key | Key designation | Description |
|--------|--------------------------|--|
| F1 | LINE CONV* | Line conversion function OFF: No line conversion; when a 1035 tape is played back, 1080 signals with black bands added at the top and bottom of the picture are output. ON: Conversion from 1035 to 1080 lines. |
| F2-5 | — | |
| F6 | SERIAL SYS PHASE | Assumes white-on-black display (VAR mode) when the F key and F6 key are pressed simultaneously, and can be adjusted with the ADJUST control. Adjustment is possible up to a maximum of ± 0.5 H (depending on the format). ± 1375 SAMPLE: 1080/23p, 1080/24p and 1080/25p formats ± 1320 SAMPLE: 1080/50i format ± 1100 SAMPLE: 1080/59i format ± 825 SAMPLE: 720/59p format (1_SAMPLE=13.5 nSEC) Adjustment is by sample increments. |
| F7 | INTERP. Interpolation | Initiates vertical interpolation during AT playback to reduce the vertical movement of the playback images. AUTO: Automatically initiates interpolation in the JOG or VAR mode. OFF: No interpolation. |
| F8 | EXIT | Returns the VTR to the VIDEO OUT HD menu screen. |
| F9-F11 | — | |
| F12 | STATE | Transfers the VTR to the VIDEO OUT HD SET UP STATE menu screen. |
| F13 | — | |

*This item only displays and functions when the 1080/59i format has been selected.

<Note>

Bear in mind that the top and bottom of the picture will be missing when ON is selected as the LINE CONV setting and a 1080 tape is played back.

VIDEO OUT HD SET UP STATE menu

This menu is displayed by pressing the following keys: VIDEO OUT (or AUDIO OUT) → F8 → F12
 OR
 VIDEO OUT → F9 → F11 (or F12) → F12

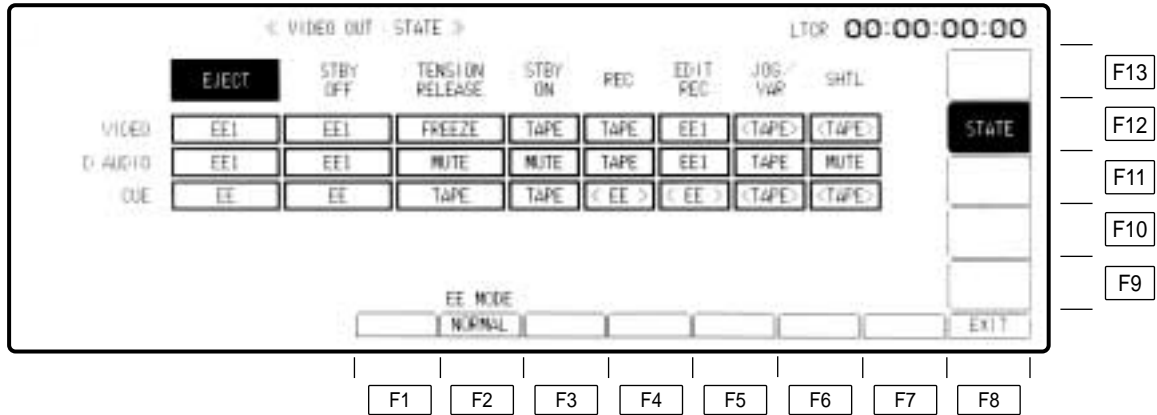

| Key | Key designation | Description |
|--------|-----------------|--|
| F1 | — | |
| F2 | EE_MODE | NORMAL: The standard mode is established (E-E through mode is turned OFF). THROUGH: When the EE/EE1 is selected, the E-E through mode (AV minimum delay mode) is established. *A discrepancy occurs between the video (audio) output and time code output in the E-E through mode. |
| F3–F7 | — | |
| F8 | EXIT | Transfers the VTR to the VIDEO OUT HD SET UP menu screen. |
| F9–F11 | — | |
| F12 | STATE | Transfers the VTR to the VIDEO OUT HD SET UP menu screen. |
| F13 | — | |

VIDEO OUT HD SET UP STATE menu

□ Selecting the TAPE/EE output signals

The video, audio and cue signals which are output during the VTR's operation are switched on this menu to TAPE or EE signals.

- (1) Press the center cursor key to display the cursor.

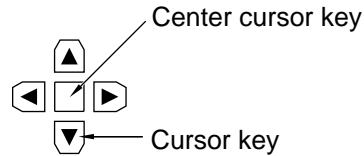

- (2) Move the cursor to the desired position using the cursor keys.
*The cursor will not move to places which cannot be set.

| | | | | | | | | |
|---------|--------------|------------|-----------------|-------------|-------------|------------|-------------|-------------|
| | <u>EJECT</u> | STEP OFF | TENSION RELEASE | STEP ON | REC. | EDIT REC. | JOG/ VAR | SHTL |
| VIDEO | <u>EE1</u> | <u>EE1</u> | <u>FREEZE</u> | <u>TAPE</u> | <u>TAPE</u> | <u>EE1</u> | <u>TAPE</u> | <u>TAPE</u> |
| D.AUDIO | <u>EE1</u> | <u>EE1</u> | <u>MUTE</u> | <u>MUTE</u> | <u>TAPE</u> | <u>EE1</u> | <u>TAPE</u> | <u>MUTE</u> |
| CUE | <u>EE</u> | <u>EE</u> | <u>TAPE</u> | <u>TAPE</u> | <u>EE</u> | <u>EE</u> | <u>TAPE</u> | <u>TAPE</u> |

- (3) Press the center cursor key to select TAPE or EE.
Refer to the following table for the types of setting options.

| Mode \ CH | EJECT | STBY OFF | TENSION RELEASE | STBY ON | REC | EDIT REC | JOG/ VAR | SHTL |
|-----------|---|---|---|---|---|---------------------------|----------------------------|----------------------------|
| VIDEO | <u>FREEZE</u> <u>BLACK</u> <u>GRAY</u> <u>FREE</u> <u>NOISE</u> <u>EE1</u> <u>EE2</u> | <u>FREEZE</u> <u>BLACK</u> <u>GRAY</u> <u>FREE</u> <u>NOISE</u> <u>EE1</u> <u>EE2</u> | <u>FREEZE</u> <u>BLACK</u> <u>GRAY</u> <u>FREE</u> <u>NOISE</u> <u>EE1</u> <u>EE2</u> | <u>TAPE</u> <u>EE1</u> <u>EE2</u> | <u>TAPE</u> <u>EE1</u> <u>EE2</u> | <u>TAPE</u> <u>EE1</u> | <u>TAPE</u> | <u>TAPE</u> |
| D.AUDIO | <u>MUTE</u> <u>EE1</u> <u>EE2</u> | <u>MUTE</u> <u>EE1</u> <u>EE2</u> | <u>MUTE</u> <u>EE1</u> <u>EE2</u> | <u>MUTE</u> <u>EE1</u> <u>EE2</u> | <u>TAPE</u> <u>EE1</u> <u>EE2</u> | <u>TAPE</u> <u>EE1</u> | <u>TAPE</u> <u>MUTE</u> | <u>TAPE</u> <u>MUTE</u> |
| CUE | <u>TAPE</u> <u>EE</u> | <u>TAPE</u> <u>EE</u> | <u>TAPE</u> <u>EE</u> | <u>TAPE</u> <u>EE</u> | <u>EE</u> | <u>EE</u> | <u>TAPE</u> | <u>TAPE</u> |

(Underline denotes the factory setting mode.)

- When a setting is to be established during head selection using the TEST menu or during editing, the setting applying to the operation concerned takes precedence over the setting selected using the VIDEO OUT SET UP STATE menu.
- When TAPE/EE has been set by F1 (OUTPUT) on the HOME menu, the HOME menu setting takes precedence.

VIDEO OUT SD menu

This menu is displayed by pressing the following keys: VIDEO OUT → F9

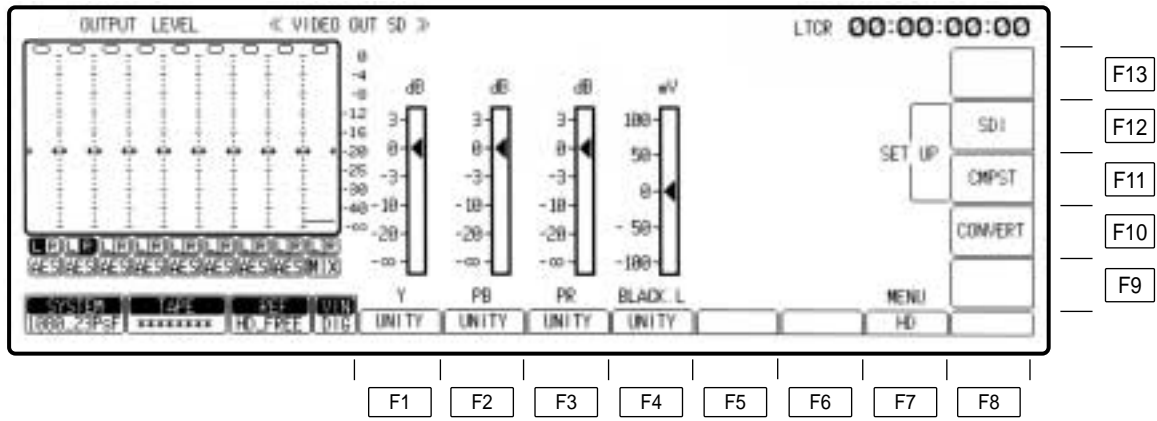

VIDEO OUT SD menu

| Key | Key designation | Description |
|-------|---|--|
| F1 | Y For adjusting the Y level. | $-\infty$ to +3 dB (–3 dB to +3 dB in fine adjustment mode) ● Establishes the fine adjustment mode if the key is pressed together with the F key. |
| F2 | P _B For adjusting the P _B level. | $-\infty$ to +3 dB (–3 dB to +3 dB in fine adjustment mode) ● Establishes the fine adjustment mode if the key is pressed together with the F key. |
| F3 | P _R For adjusting the P _R level. | $-\infty$ to +3 dB (–3 dB to +3 dB in fine adjustment mode) ● Establishes the fine adjustment mode if the key is pressed together with the F key. |
| F4 | BLACK.L For adjusting the black level. | ± 100 mV |
| F5–F6 | — | |
| F7 | HD | Transfers the VTR to the VIDEO OUT HD menu screen. |
| F8–F9 | — | |
| F10 | CONVERT | Transfers the VTR to the VIDEO OUT CONVERT menu screen. |
| F11 | CMPST | Transfers the VTR to the VIDEO OUT SD SET UP COMPOSITE menu screen. |
| F12 | SDI | Transfers the VTR to the VIDEO OUT SD SET UP SDI menu screen. |
| F13 | — | |

VIDEO OUT SD SET UP COMPOSITE menu

This menu is displayed by pressing the following keys: VIDEO OUT → F9 → F11

The screenshot shows a menu titled '<< VIDEO OUT - SD SET UP - COMPT >>' with a timer 'LTOP: 00:00:00:00' in the top right. The menu contains several settings and options:

- SYS SC: [0] DEGREE
- SYS H: [0] SAMPLES
- STATE
- LINE BLK
- T. BUSTUP OFF
- EXIT
- COMB FIL: ON
- B.CLIP: OFF
- SYS SC: UNITY
- SYS H: UNITY
- INTERP: AUTO

Function key callouts are as follows:

- F13: points to the top right corner of the menu.
- F12: points to the STATE option.
- F11: points to the LINE BLK option.
- F10: points to the T. BUSTUP OFF option.
- F9: points to the EXIT option.
- F1: points to the COMB FIL ON option.
- F2: points to the B.CLIP OFF option.
- F3: points to the empty box between B.CLIP and SYS SC.
- F4: points to the empty box between SYS SC and SYS H.
- F5: points to the SYS SC UNITY option.
- F6: points to the SYS H UNITY option.
- F7: points to the INTERP AUTO option.
- F8: points to the empty box between INTERP and EXIT.

VIDEO OUT SD SET UP COMPOSITE menu

| Key | Key designation | Description |
|-------|--|--|
| F1 | COMB FIL* For controlling the comb filter. | Selects whether the analog composite output signals are to be passed through the comb filter. However, when the F1 (COMB FIL) key on the VIDEO OUT SD SET UP SDI menu has been set to ON, the analog composite output will also be set to ON regardless of which setting is selected for this menu item. ON: The signals are passed through the filter and output. OFF: The signals are not passed through the filter. |
| F2 | B. CLIP | This is used to select whether signals below the SD output pedestal level are to be clipped or not. OFF: The signals are not clipped. ON: The signals are clipped. |
| F3–F4 | — | |
| F5 | SYS SC For adjusting the system subcarrier. | Adjusts the system subcarrier of the composite output. (–180 to +180) When this key is pressed together with the F key, the white-on-black display (VAR MODE) is established, and the system subcarrier can be adjusted using the ADJUST control. |
| F6 | SYS H For adjusting the system H phase. | Adjusts the system H phase of the composite output. Adjusts the system H phase of the composite output. When this key is pressed together with the F key, the white-on-black display (VAR MODE) is established, and the system H phase can be adjusted using the ADJUST control. The system H phase is adjusted in sample increments. $\pm 0.5H$ –858 to +858 (with 480/59.94i format) –864 to +864 (with 576/50i format) |
| F7 | INTERP. Interpolation | Initiates vertical interpolation during AT playback to reduce the vertical movement of the playback images. AUTO: Automatically initiates interpolation in the JOG or VAR mode. OFF: No interpolation. |
| F8 | EXIT | Returns the VTR to the VIDEO OUT SD menu screen. |
| F9 | — | |
| F10 | 7.5%STUP For adding 7.5% setup to the composite output. | Selects whether to add 7.5% setup to the composite output. (This setting takes effect with NTSC output signals only; This setting is not displayed with PAL output signals.) ON: 7.5% setup is added. OFF: 7.5% setup is not added. |
| F11 | LINE BLK | For transferring to the video output line blanking menu. NTSC: Lines 10 to 21. PAL: Lines 8 to 22. |
| F12 | STATE | Transfers the VTR to the VIDEO OUT SD SET UP CMPST STATE menu screen. |
| F13 | — | |

* This item does not appear with the 1080/50i, 625/50i, 1080/25psf and 1080/25p system formats. (PAL output signals are not passed through the filter.)

VIDEO OUT SD SET UP CMPST STATE menu

This menu is displayed by pressing the following keys: VIDEO OUT (or [AUDIO OUT]) → F8 → F12
 OR
 VIDEO OUT → F9 → F11 (or F12) → F12

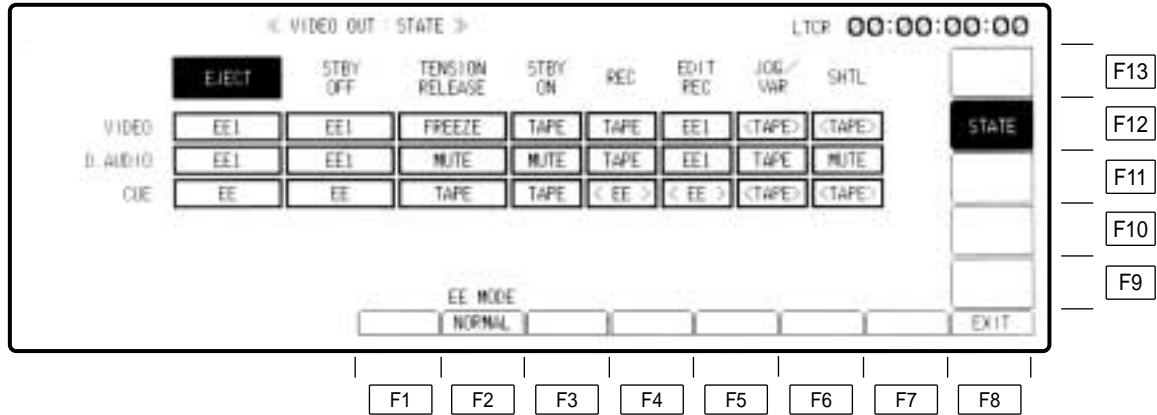

| Key | Key designation | Description |
|--------|-----------------|--|
| F1 | — | |
| F2 | EE_MODE | <p>NORMAL: The standard mode is established (E-E through mode is turned OFF).</p> <p>THROUGH: The E-E through mode (AV minimum delay mode) is established.</p> <p>*A discrepancy occurs between the video (audio) output and time code output in the E-E through mode.</p> |
| F3-F7 | — | |
| F8 | EXIT | Transfers the VTR to the VIDEO OUT SD SET UP CMPST menu screen. |
| F9-F13 | — | |

VIDEO OUT SD SET UP CMPST STATE menu

□ Selecting the TAPE/EE output signals

The video, audio and cue signals which are output during the VTR's operation are switched on this menu to TAPE or EE signals.

- (1) Press the center cursor key to display the cursor.

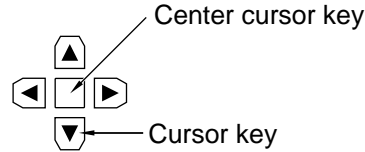

- (2) Move the cursor to the desired position using the cursor keys.
*The cursor will not move to places which cannot be set.



- (3) Press the center cursor key to select TAPE or EE.
Refer to the following table for the types of setting options.

| Mode CH | EJECT | STBY OFF | TENSION RELEASE | STBY ON | REC | EDIT REC | JOG/ VAR | SHTL |
|----------------|---|---|---|---------------------------|---------------------------|---------------------------|---------------------|---------------------|
| VIDEO | FREEZE BLACK GRAY FREE NOISE <u>EE1</u> EE2 | FREEZE BLACK GRAY FREE NOISE <u>EE1</u> EE2 | <u>FREEZE</u> BLACK GRAY FREE NOISE EE1 EE2 | <u>TAPE</u> EE1 EE2 | <u>TAPE</u> EE1 EE2 | <u>TAPE</u> <u>EE1</u> | TAPE | TAPE |
| D.AUDIO | MUTE <u>EE1</u> EE2 | MUTE <u>EE1</u> EE2 | <u>MUTE</u> EE1 EE2 | <u>MUTE</u> EE1 EE2 | <u>TAPE</u> EE1 EE2 | <u>TAPE</u> <u>EE1</u> | <u>TAPE</u> MUTE | <u>TAPE</u> MUTE |
| CUE | <u>TAPE</u> EE | <u>TAPE</u> EE | <u>TAPE</u> EE | <u>TAPE</u> EE | EE | EE | TAPE | TAPE |

(Underline denotes the factory setting mode.)

- When a setting is to be established during head selection using the TEST menu or during editing, the setting applying to the operation concerned takes precedence over the setting selected using the VIDEO OUT SET UP STATE menu.
- When TAPE/EE has been set by F1 (OUTPUT) on the HOME menu, the HOME menu setting takes precedence.

VIDEO OUT SD SET UP SDI menu

This menu is displayed by pressing the following keys: VIDEO OUT → F9 → F12

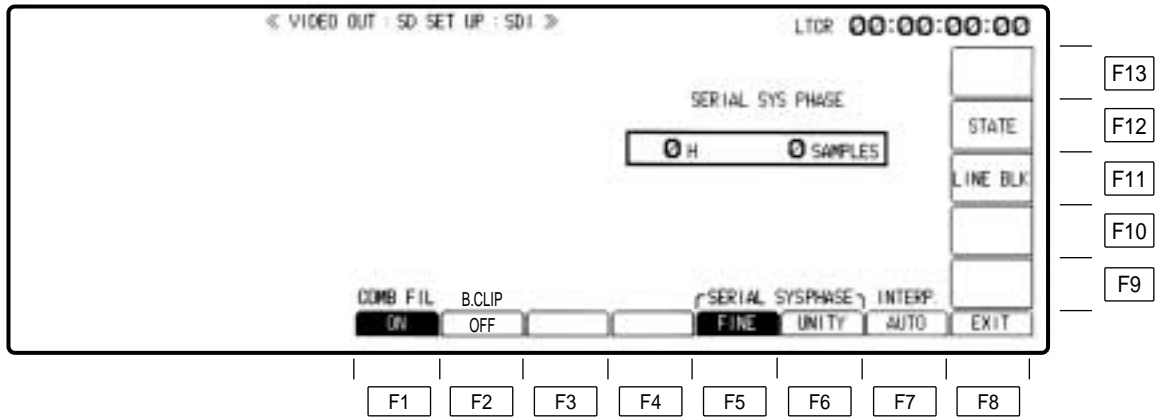

VIDEO OUT SD SET UP SDI menu

| Key | Key designation | Description |
|----------|--------------------------|--|
| F1 | COMB FIL* | For selecting whether to pass the SD output (both of SDI output and analog composite output) signals through the comb filter. ON: The signals are passed through the comb filter and output. OFF: The signals are not passed through the comb filter. |
| F2 | B. CLIP | This is used to select whether signals below the SD output pedestal level are to be clipped or not. OFF: The signals are not clipped. ON: The signals are clipped. |
| F3–F4 | — | |
| F5 F6 | SERIAL SYS PHASE | Adjusts the sync phase of SD_SDI output in relation to the reference signal. FINE/COARSE ● This can be selected when the function key is pressed together with the F key. With the 480/59.94i format: Adjustment can be made from –2H-858 to +1H+858. With the 480/59.94p format: Adjustment can be made from –857 to +858. With the 576/50i format: Adjustment can be made from –2H-864 to +1H+864. For <u>FINE</u> , adjustments are made in sample increments; for <u>COARSE</u> , they are made in H increments. |
| F7 | INTERP. Interpolation | Initiates vertical interpolation during AT playback to reduce the vertical movement of the playback images. AUTO: Automatically initiates interpolation in the JOG or VAR mode. OFF: No interpolation. |
| F8 | EXIT | Returns the VTR to the VIDEO OUT SD menu screen. |
| F9–F10 | — | |
| F11 | LINE BLK | For transferring to the video output line blanking menu. NTSC: Lines 10 to 21. PAL: Lines 8 to 22. |
| F12 | STATE | Transfers the VTR to the VIDEO OUT SD SET UP SDI STATE menu screen. |
| F13 | — | |

*This item does not appear when 525p (480/59p) is set for the SD SDI output. Similarly, it does not appear when 1080/50i, 625/50i, 1080/25psf or 1080/25p is the system format. (The output signals are not passed through the comb filter.)

VIDEO OUT SET UP LINE BLK (video output line blanking) menu

This menu is displayed by pressing the following keys: VIDEO OUT → F9 → F11 (or F12) → F11.

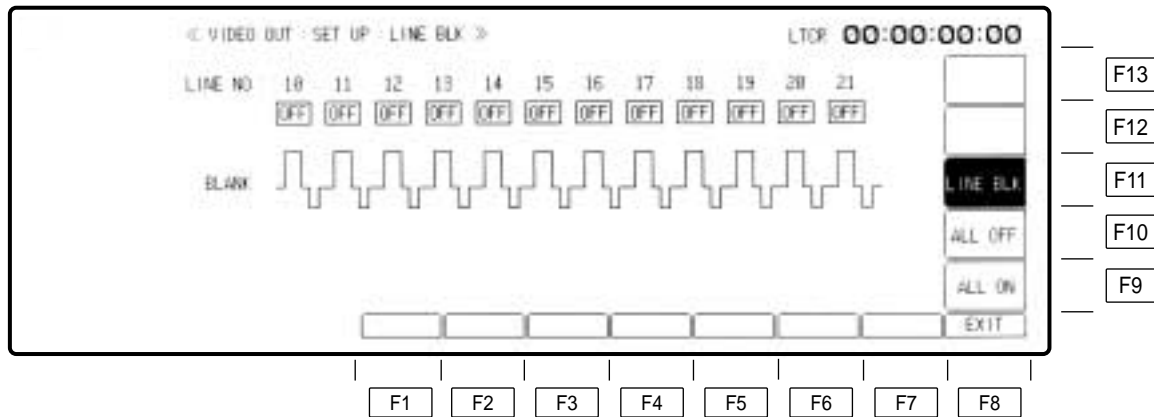

| Key | Key designation | Description |
|---------|-----------------|--|
| F1-F7 | — | |
| F8 | EXIT | Returns the VTR to the VIDEO OUT SD SET UP menu screen. |
| F9 | ALL ON | When this key is pressed together with the F key, all the lines are blanked. |
| F10 | ALL OFF | When this key is pressed together with the F key, all the lines are non-blanked. |
| F11 | LINE BLK | Refer to the "Setting the line blanking" (on the next page). |
| F12-F13 | — | |

VIDEO OUT SET UP LINE BLK (video output line blanking) menu

□ Setting the line blanking

The blanking lines in the vertical blanking period can be set in 1-line increments.

- (1) Press the center cursor key.
The cursor now appears.

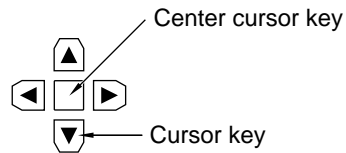

- (2) Move the cursor and select the lines to be blanked.

OFF



- (3) Press the center cursor key to select ON or OFF for the display.

ON



ON: The lines are blanked.

OFF: The non-blanking status is established, and no lines are selected.

- (4) Press the ENT key.
The blanking is now entered.
- (5) To return to the previous screen, press the F8 (EXIT) key.

VIDEO OUT SD SET UP SDI STATE menu

This menu is displayed by pressing the following keys: VIDEO OUT (or AUDIO OUT) → F8 → F12
 OR
 VIDEO OUT → F9 → F11 (or F12) → F12.

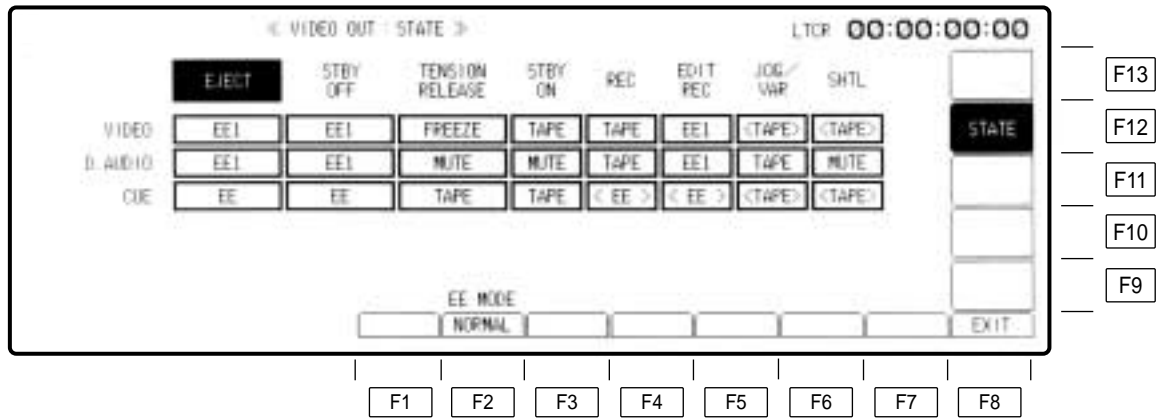

| Key | Key designation | Description |
|--------|-----------------|--|
| F1 | — | |
| F2 | EE_MODE | <p>NORMAL: The standard mode is established (E-E through mode is turned OFF).</p> <p>THROUGH: The E-E through mode (AV minimum delay mode) is established.</p> <p>*A discrepancy occurs between the video (audio) output and time code output in the E-E through mode.</p> |
| F3-F7 | — | |
| F8 | EXIT | Transfers the VTR to the VIDEO OUT SD SET UP SDI menu screen. |
| F9-F13 | — | |

VIDEO OUT SET UP STATE menu

□ Selecting the TAPE/EE output signals

The video, audio and cue signals which are output during the VTR's operation are switched on this menu to TAPE or EE signals.

- (1) Press the center cursor key to display the cursor.

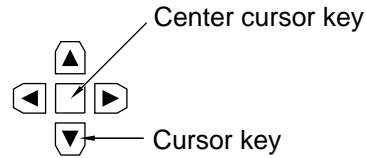

- (2) Move the cursor to the desired position using the cursor keys.

*The cursor will not move to places which cannot be set.

| | | | | | | | | |
|---------|--------------|----------|-----------------|---------|------|----------|----------|--------|
| | EJECT | STBY OFF | TENSION RELEASE | STBY ON | REC | EDIT REC | JOG/ VAR | SHTL |
| VIDEO | EE1 | EE1 | FREEZE | TAPE | TAPE | EE1 | <TAPE> | <TAPE> |
| D.AUDIO | EE1 | EE1 | MUTE | MUTE | TAPE | EE1 | TAPE | MUTE |
| CUE | EE | EE | TAPE | TAPE | <EE> | <EE> | <TAPE> | <TAPE> |

- (3) Press the center cursor key to select TAPE or EE.
Refer to the following table for the types of setting options.

| Mode \ CH | EJECT | STBY OFF | TENSION RELEASE | STBY ON | REC | EDIT REC | JOG/ VAR | SHTL |
|----------------|---|---|--|--------------------|--------------------|--------------------|--------------|--------------|
| VIDEO | FREEZE BLACK GRAY FREE NOISE <u>EE1</u> EE2 | FREEZE BLACK GRAY FREE NOISE <u>EE1</u> EE2 | FREEZE BLACK GRAY FREE NOISE EE1 EE2 | TAPE EE1 EE2 | TAPE EE1 EE2 | TAPE <u>EE1</u> | TAPE | TAPE |
| D.AUDIO | MUTE <u>EE1</u> EE2 | MUTE <u>EE1</u> EE2 | MUTE EE1 EE2 | MUTE EE1 EE2 | TAPE EE1 EE2 | TAPE <u>EE1</u> | TAPE MUTE | TAPE MUTE |
| CUE | TAPE <u>EE</u> | TAPE <u>EE</u> | TAPE EE | TAPE EE | EE | EE | TAPE | TAPE |

(Underline denotes the factory setting mode.)

- When a setting is to be established during head selection using the TEST menu or during editing, the setting applying to the operation concerned takes precedence over the setting selected using the VIDEO OUT SET UP STATE menu.
- When TAPE/EE has been set by F1 (OUTPUT) on the HOME menu, the HOME menu setting takes precedence.

VIDEO OUT CONVERT menu

This menu is displayed by pressing the following keys: VIDEO OUT → F10

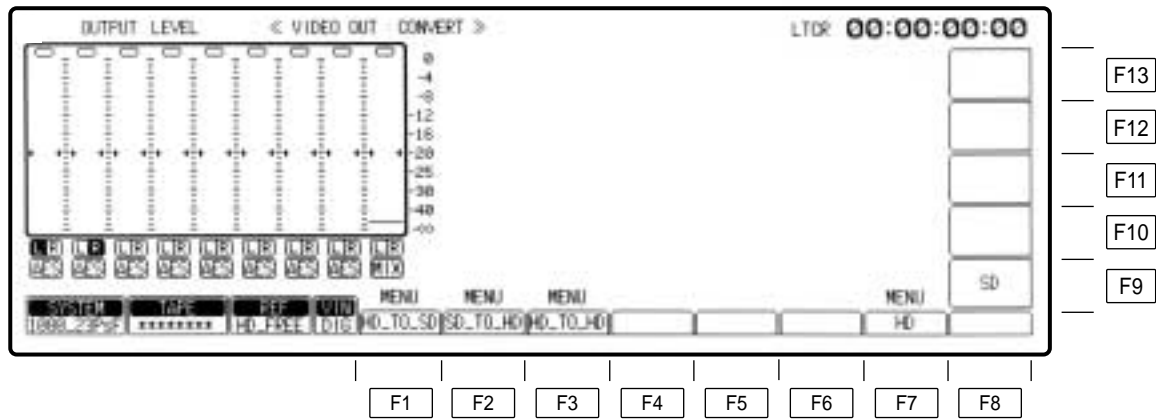

| Key | Key designation | Description |
|---------|-----------------|--|
| F1 | HD_TO_SD | Transfers the VTR to the VIDEO OUT CONVERT HD TO SD menu screen. |
| F2 | SD_TO_HD | Transfers the VTR to the VIDEO OUT CONVERT SD TO HD menu screen. |
| F3 | HD_TO_HD | Transfers the VTR to the VIDEO OUT CONVERT HD TO HD menu screen. |
| F4-F6 | — | |
| F7 | HD | Returns the VTR to the VIDEO OUT HD menu screen. |
| F8 | — | |
| F9 | SD | Returns the VTR to the VIDEO OUT SD menu screen. |
| F10-F13 | — | |

VIDEO OUT CONVERT HD_TO_SD menu

This menu is displayed by pressing the following keys: VIDEO OUT → F10 → F1

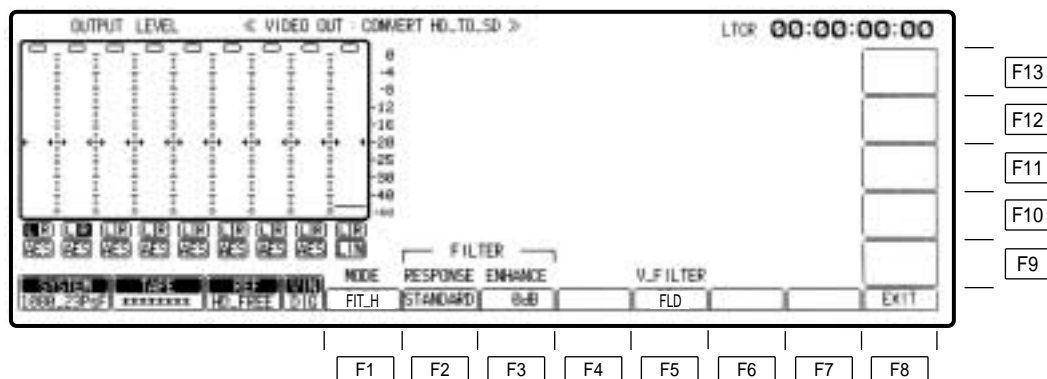

| Key | Key designation | Description |
|--------|-----------------|--|
| F1 | MODE | <p>Selects the aspect ratio at which signals are output from the down-converter.</p> <p>FIT_V: Changes the magnification by matching the input size to the output size along the vertical axis. (The aspect ratio remains the same.)</p> <p>FIT_H: Changes the magnification by matching the input size to the output size along the horizontal axis. (The aspect ratio remains the same.)</p> <p>FIT_HV: Changes the magnification by matching the input size to the output size along the horizontal and vertical axes. (The aspect ratio may be distorted.)</p> <p>14:9: Sets the aspect ratio to 14×9.</p> <p>13:9: Sets the aspect ratio to 13×9.</p> <p>*When the 525p (480/59.94p) has been selected for the SD SDI MAIN output, the aspect ratio remains fixed at 16:9.</p> |
| F2 | RESPONSE | <p>Selects the frequency bandwidth of the down-converter output signals.</p> <p>STANDARD/WIDE/NARROW</p> |
| F3 | ENHANCE | <p>Controls the enhancement adjustment of the down-converter output signals.</p> <p>0dB/1.5dB/3dB/6dB</p> |
| F4 | — | |
| F5 | V_FILTER | <p>This item appears only when the 1080p (psf) has been selected as the system format.</p> <p>This is the extension function for vertical frequency characteristic in down converter output signals.</p> <p>FLD: Filter field processing</p> <p>FRM: Filter frame processing</p> <p>FRM2: This item appears only when the 1080/23p (psf) has been selected as the system format. F10 to F13 key menus are displayed when FRM2 has been selected, and then the horizontal and vertical characteristics can be controlled independently. (See page 44.)</p> |
| F6 | V_EXTEND | <p>This item appears only when the 1080/59i has been selected as the system format. (See page 45.)</p> <p>Selects ON or OFF.</p> <p>F10 to F13 key menus are displayed when ON has been selected, and then the horizontal and vertical characteristics can be controlled independently.</p> |
| F7 | — | |
| F8 | EXIT | Returns the VTR to the VIDEO OUT CONVERT menu screen. |
| F9–F13 | — | |

VIDEO OUT CONVERT HD_TO_SD menu

The following menu is displayed when FMR2 has been selected with the F5 (V_FILTER) key in the system format 1080/23p (psf). (The characteristic of H and V can be controlled independently.)

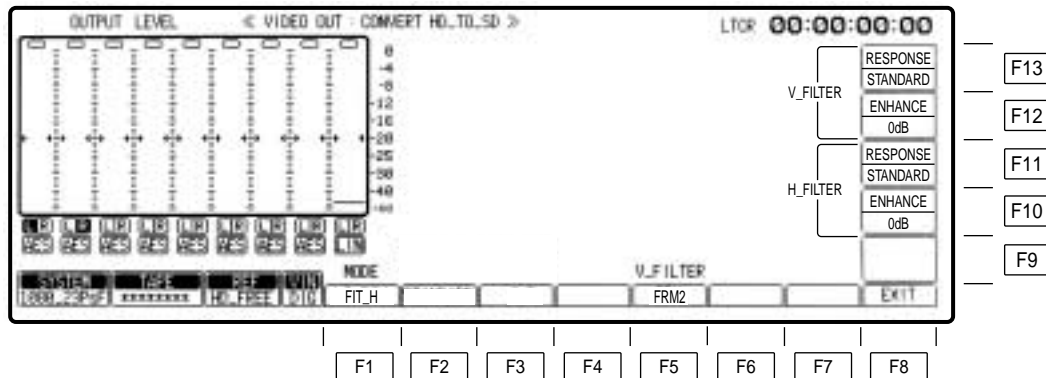

| Key | Key designation | Description |
|-----|-------------------|---|
| F10 | H_FILTER ENHANCE | Sets the picture quality (horizontal frequency characteristic). 0/0.75/1.0/1.25/1.5/2.0/3.0 |
| F11 | H_FILTER RESPONSE | Sets the picture quality (horizontal frequency bandwidth). STANDARD/WIDE/NARROW |
| F12 | V_FILTER ENHANCE | Sets the picture quality (vertical frequency characteristic). 0/0.75/1.0/1.25/1.5/2.0/3.0 |
| F13 | V_FILTER RESPONSE | Sets the picture quality (vertical frequency bandwidth). STANDARD/WIDE/NARROW |

<Note>

When F and F10 or F and F12 are pressed at the same time in the F10 (H_FILTER ENHANCE) or F12 (V_FILTER ENHANCE) setting, the setting value is highlighted and can be changed using the ADJUST VR control. When either F and F10 or F and F12 are pressed together once again, the highlighting disappears, making it no longer possible to perform settings with the ADJUST VR control. This returns the ADJUST VR control to toggle mode with the function key.

VIDEO OUT CONVERT HD_TO_SD menu

The following menu is displayed when ON has been selected with the F6 (V_EXTEND) key in the system format 1080/59i. (The characteristic of H and V can be controlled independently.)

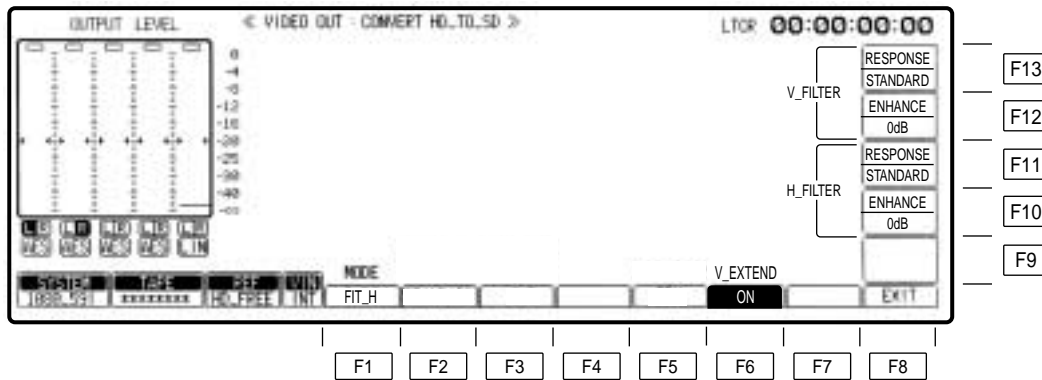

| Key | Key designation | Description |
|-----|-------------------|---|
| F10 | H_FILTER ENHANCE | Sets the picture quality (horizontal frequency characteristic). 0/1.0/2.0/3.0/4.0/5.0/6.0 |
| F11 | H_FILTER RESPONSE | Sets the the picture quality (horizontal frequency bandwidth). STANDARD/WIDE/NARROW |
| F12 | V_FILTER ENHANCE | Sets the the picture quality (vertical frequency characteristic). 0/0.5/1.0/1.5/2.0/3.0/4.0 |
| F13 | V_FILTER RESPONSE | Sets the the picture quality (vertical frequency bandwidth). STANDARD/WIDE/NARROW |

<Note>

When F and F10 or F and F12 are pressed at the same time in the F10 (H_FILTER ENHANCE) or F12 (V_FILTER ENHANCE) setting, the setting value is highlighted and can be changed using the ADJUST VR control.

When either F and F10 or F and F12 are pressed together once again, the highlighting disappears, making it no longer possible to perform settings with the ADJUST VR control.

This returns the ADJUST VR control to toggle mode with the function key.

VIDEO OUT CONVERT SD_TO_HD menu

This menu is displayed by pressing the following keys: VIDEO OUT → F10 → F2

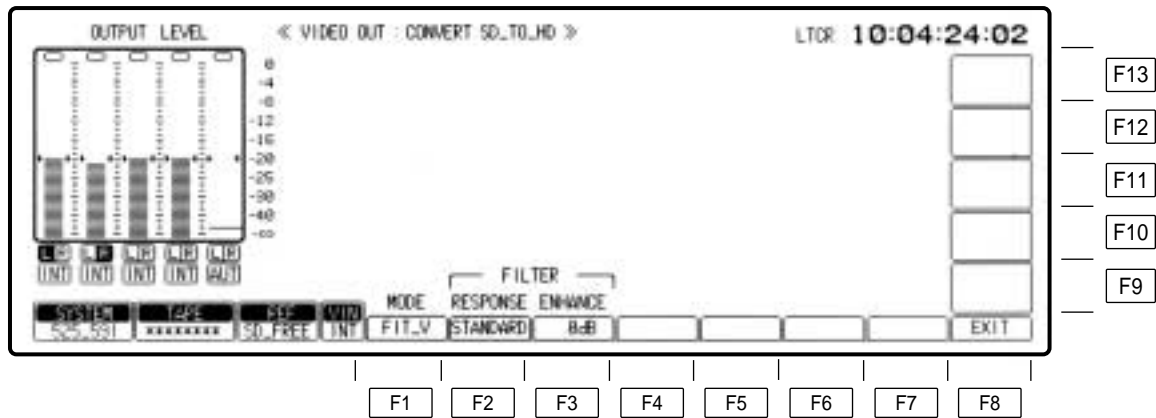

| Key | Key designation | Description |
|--------|-----------------|--|
| F1 | MODE | Selects the aspect ratio at which signals are output from the up-converter. FIT_V: Changes the magnification by matching the input size to the output size along the vertical axis. (The aspect ratio remains the same.) FIT_H: Changes the magnification by matching the input size to the output size along the horizontal axis. (The aspect ratio remains the same.) FIT_HV: Changes the magnification by matching the input size to the output size along the horizontal and vertical axes. (The aspect ratio may be distorted.) |
| F2 | RESPONSE | Selects the frequency bandwidth of the up-converter output signals. STANDARD/WIDE/NARROW |
| F3 | ENHANCE | Controls the enhancement adjustment of the up-converter output signals. 0dB/1.5dB/3dB/6dB |
| F4–F7 | — | |
| F8 | EXIT | Returns the VTR to the VIDEO OUT CONVERT menu screen. |
| F9–F13 | — | |

VIDEO OUT CONVERT HD_TO_HD menu

This menu is displayed by pressing the following keys: VIDEO OUT → F10 → F3

*This menu is operational when 1080/23.98p, 1080/24p or 1080/25p has been set as the system format.

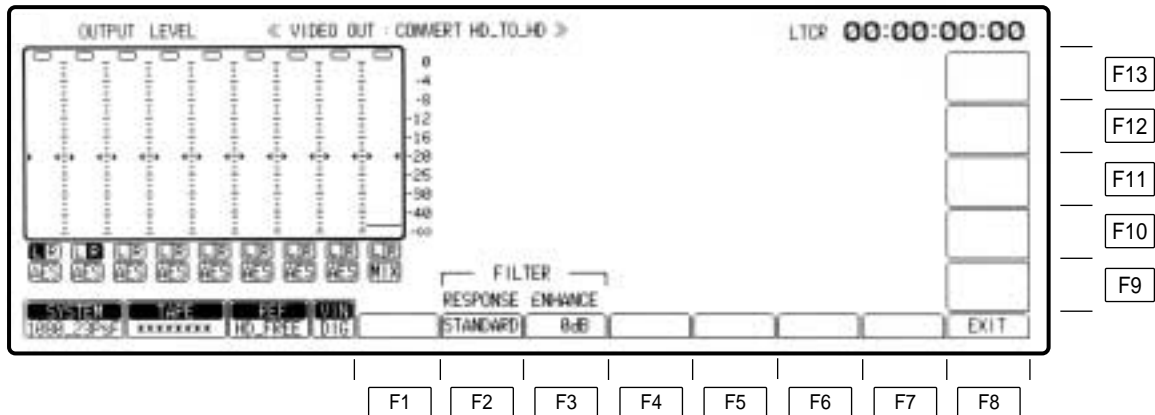

| Key | Key designation | Description |
|--------|-----------------|--|
| F1 | — | — |
| F2 | RESPONSE | Selects the frequency bandwidth of the converter output signals. STANDARD/WIDE/NARROW |
| F3 | ENHANCE | Controls the enhancement adjustment of the converter output signals. 0dB/1.5dB/3dB/6dB |
| F4–F7 | — | — |
| F8 | EXIT | Returns the VTR to the VIDEO OUT CONVERT menu screen. |
| F9–F13 | — | — |

AUDIO IN menu

This menu is displayed by pressing the following key: **AUDIO IN**

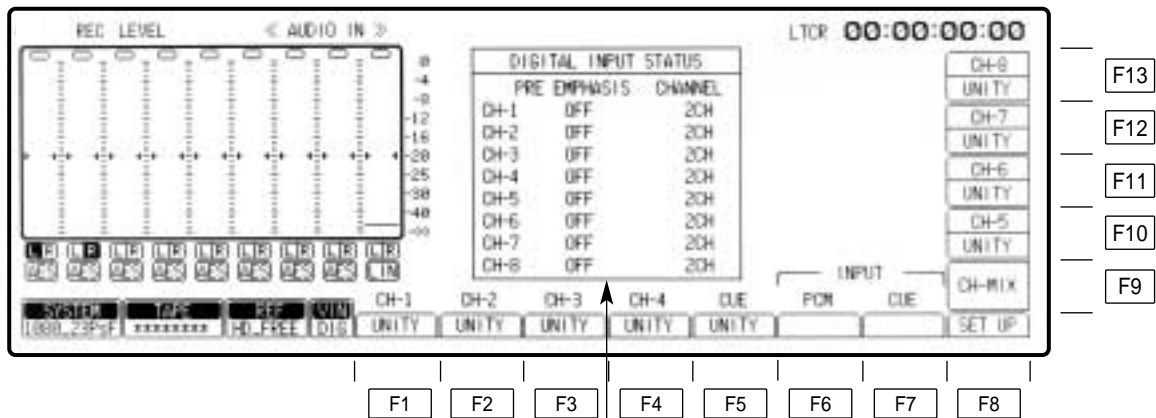

The digital audio input statuses are displayed here.

PRE EMPHASIS ON: Pre-emphasis is applied to the input signals.
OFF: Regular signals with no pre-emphasis are supplied.

AUDIO IN menu

| Key | Key designation | Description |
|-----|---|--|
| F1 | CH-1 For adjusting the audio CH1 input level. | |
| F2 | CH-2 For adjusting the audio CH2 input level. | |
| F3 | CH-3 For adjusting the audio CH3 input level. | UNITY: Input level is fixed at UNITY value. VAR: Input level can be varied with ADJUST control. ●For switchover, press the UNITY/VAR button. |
| F4 | CH-4 For adjusting the audio CH4 input level. | |
| F5 | CUE For adjusting the cue audio input level. | |
| F6 | PCM | Transfers the VTR to AUDIO IN PCM INPUT SELECT menu screen. |
| F7 | CUE | Transfers the VTR to the AUDIO IN CUE INPUT menu screen. |
| F8 | SET UP | Transfers the VTR to the AUDIO IN SET UP menu screen. |
| F9 | CH-MIX | Transfers the VTR to the AUDIO IN CH-MIX SELECT menu screen. |
| F10 | CH-5 For adjusting the audio CH5 input level. | |
| F11 | CH-6 For adjusting the audio CH6 input level. | UNITY: Input level is fixed at UNITY value. VAR: Input level can be varied with ADJUST control. ●For switchover, press the UNITY/VAR button. |
| F12 | CH-7 For adjusting the audio CH7 input level. | |
| F13 | CH-8 For adjusting the audio CH8 input level. | |

AUDIO IN PCM INPUT SELECT menu

This menu is displayed by pressing the following keys: **AUDIO IN** → **F6**

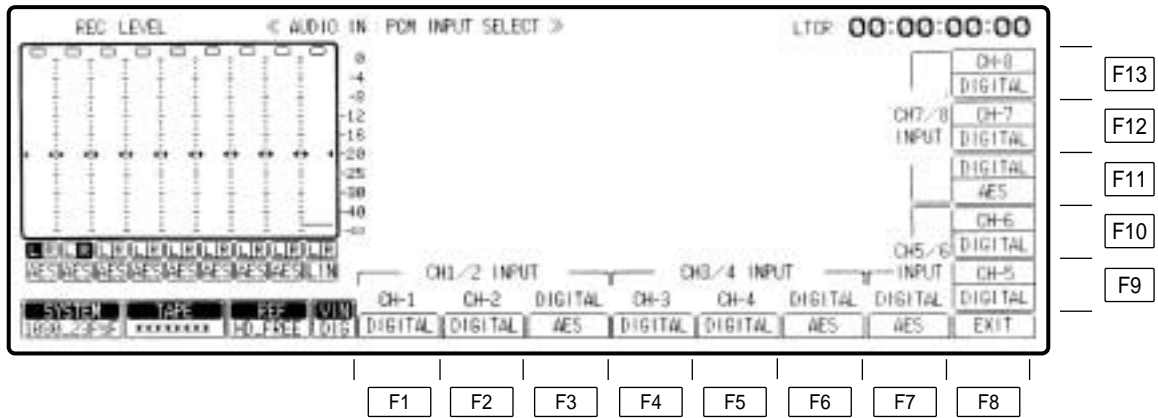

AUDIO IN PCM INPUT SELECT menu

| Key | Key designation | Description |
|-----|---|--|
| F1 | CH-1 For selecting the recording signals of digital audio CH1. | ANALOG: Selects the signals of the analog CH1 input connector. DIGITAL: Selects the digital audio input signals (AES/SDI selection is made in line with the CH2 setting using F3). INT SG: Selects the internal generator signals. |
| F2 | CH-2 For selecting the recording signals of digital audio CH2. | For selecting the recording signals of digital audio channel 2. ANALOG: Selects the signals of the analog CH2 input connector. DIGITAL: Selects the digital audio input signals (AES/SDI selection is made in line with the CH1 setting using F3). INT SG: Selects the internal generator signals. |
| F3 | DIGITAL For selecting the CH1 and CH2 digital input signals. | AES: Selects the AES digital audio input signals. SERIAL: Selects the serial input signals. |
| F4 | CH-3 For selecting the recording signals of digital audio CH3. | ANALOG: Selects the signals of the analog CH3 input connector. DIGITAL: Selects the digital audio input signals (AES/SDI selection is made in line with the CH4 setting using F6). INT SG: Selects the internal generator signals. |
| F5 | CH-4 For selecting the recording signals of digital audio CH4. | ANALOG: Selects the signals of the analog CH4 input connector. DIGITAL: Selects the digital audio input signals (AES/SDI selection is made in line with the CH3 setting using F6). INT SG: Selects the internal generator signals. |
| F6 | DIGITAL For selecting the CH3 and CH4 digital input signals. | AES: Selects the AES digital audio input signals. SERIAL: Selects the serial input signals. |
| F7 | DIGITAL For selecting the CH5 and CH6 digital input signals. | AES: Selects the AES digital audio input signals. SERIAL: Selects the serial input signals. |
| F8 | EXIT | Returns the VTR to the AUDIO IN menu screen. |
| F9 | CH-5 For selecting the recording signals of digital audio CH5. | ANA CH1: Selects the signals of the analog CH1 input connector. DIGITAL: Selects the digital audio input signals (AES/SDI selection is made in line with the CH6 setting using F7). INT SG: Selects the internal generator signals. |

AUDIO IN PCM INPUT SELECT menu

| Key | Key designation | Description |
|-----|---|--|
| F10 | CH-6 For selecting the recording signals of digital audio CH6. | <p>ANA CH2: Selects the signals of the analog CH2 input connector.</p> <p>DIGITAL: Selects the digital audio input signals (AES/SDI selection is made in line with the CH5 setting using F7).</p> <p>INT SG: Selects the internal generator signals.</p> |
| F11 | DIGITAL For selecting the CH7 and CH8 digital input signals. | <p>AES: Selects the AES digital audio input signals.</p> <p>SERIAL: Selects the serial input signals.</p> |
| F12 | CH-7 For selecting the recording signals of digital audio CH7. | <p>ANA CH3: Selects the signals of the analog CH3 input connector.</p> <p>DIGITAL: Selects the digital audio input signals (AES/SDI selection is made in line with the CH8 setting using F11).</p> <p>INT SG: Selects the internal generator signals.</p> |
| F13 | CH-8 For selecting the recording signals of digital audio CH8. | <p>ANA CH4: Selects the signals of the analog CH4 input connector.</p> <p>DIGITAL: Selects the digital audio input signals (AES/SDI selection is made in line with the CH7 setting using F11).</p> <p>INT SG: Selects the internal generator signals.</p> |

AUDIO IN CUE INPUT SELECT menu

This menu is displayed by pressing the following keys: **AUDIO IN** → **F7**

The below screen will be appeared when the menu is in the D-MIX status by pressing the **F9 (D-MIX)** key.

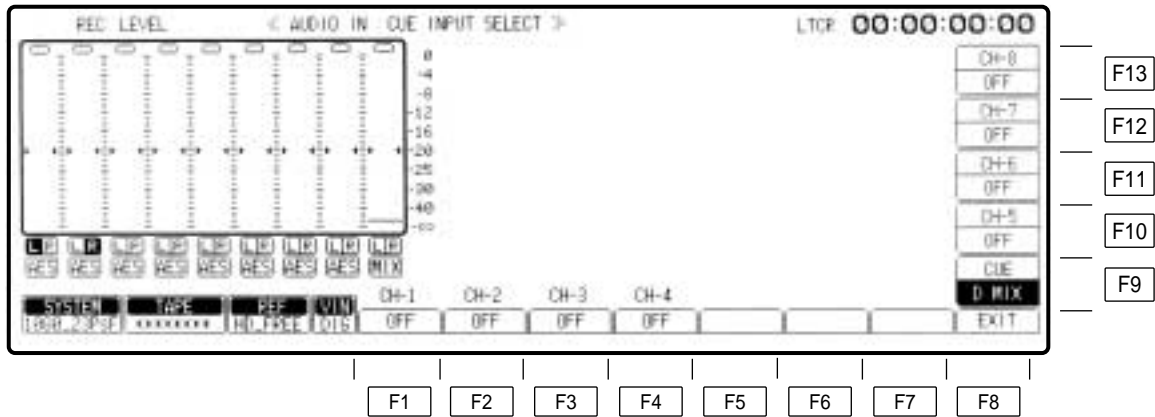

AUDIO IN CUE INPUT SELECT menu

| Key | Key designation | Description |
|-------|---|---|
| F1 | CH-1 For setting cue mixing for CH1. | |
| F2 | CH-2 For setting cue mixing for CH2. | (displayed only when D-MIX is set using F9) |
| F3 | CH-3 For setting cue mixing for CH3. | SOURCE: Mixes the input signals. TAPE: Mixes the playback signals. OFF: No mixing. |
| F4 | CH-4 For setting cue mixing for CH4. | |
| F5–F7 | — | |
| F8 | EXIT | Returns the VTR to the AUDIO IN menu screen. |
| F9 | CUE For selecting the cue audio recording signals. | For selecting the signals to be recorded on the cue track. D-MIX: Mixes and records the digital channel signals selected by D-MIX. LINE: Selects the analog cue input signals. AUTO: In the normal recording mode, mixes and records all the (CH1 to CH4)* signals; during editing, automatically selects SOURCE for selected channels and TAPE for non-selected channels. *This differs, depending on the format. |
| F10 | CH-5 For setting cue mixing for CH5. | |
| F11 | CH-6 For setting cue mixing for CH6. | (displayed only when D-MIX is set using F9) |
| F12 | CH-7 For setting cue mixing for CH7. | SOURCE: Mixes the input signals. TAPE: Mixes the playback signals. OFF: No mixing. |
| F13 | CH-8 For setting cue mixing for CH8. | |

AUDIO IN SET UP menu

This menu is displayed by pressing the following keys: **AUDIO IN** → **F8**
OR
SET UP → **F6**

The screenshot shows the 'AUDIO IN SET UP' menu. At the top left is 'REC LEVEL' with a vertical scale from 0 to -40. Below it are five sliders labeled 'L1', 'L2', 'L3', 'L4', and 'L5'. The top center shows '<< AUDIO IN SET UP >>'. The top right shows 'LTCR 00:00:00:00'. On the right side, there are four menu items: 'RATE CON' (On), 'STYLE' (PCM), 'DATA ADJ' (OFF), and 'EXIT'. At the bottom, there are several settings: 'SYSTEM' (1088.591), 'TONE' (*****), 'REF' (HO.FREE), 'INT SG MD' (INT), 'TONE', 'PEAK HOLD' (ON), and 'SCALE' (FULL). Below the screen, there are two rows of function key callouts: F1 through F8 at the bottom, and F9 through F13 on the right side, with lines connecting them to the corresponding menu items.

AUDIO IN SET UP menu

| Key | Key designation | Description |
|---------|--|--|
| F1 | INT SG MD | For selecting the internal audio test signal. -tone: Reference level sinusoidal waves are output. SILENCE: A signal tone is not output. (Mute signals are output.) |
| F2–F5 | — | |
| F6 | PEAK HOLD For setting the peak hold. | For holding the peak recording and playback levels on the display. ON: Peak level is held. OFF: Peak level is not held. |
| F7 | SCALE For switching the level meter scale. | For switching the scale of the audio level meter on display to standard scale or fine scale. FINE: Scale in 0.2 dB increments. (–24dB to –15dB) FULL: Standard scale (–∞ to –0dB) Refer to “Switching the audio level meter scale” (on this page). |
| F8 | EXIT | Returns the VTR to the AUDIO IN menu screen. |
| F9 | DATA ADV*1 | 0–1 Fr (in increments of 1/10th of a frame): The amount by which the data is to be advanced when the digital audio input/output format is in the data mode can be set in increments of 1/10th of a frame. (When “0” is set, the amount is set to the default setting inside the VTR.) |
| F10 | STYLE*1 For setting the digital audio input/output data format. | This menu item can be set by pressing the F10 key together with the F key. PCM: The format is set to the regular PCM audio mode. DATA: The format is set to the data mode (compressed audio: Dolby-E*2). |
| F11 | RATE CON*3 | This enables recording and playback to be conducted either through the rate converter in the AUDIO I/O area and with the digital filter activated (function ON) or with the rate converter bypassed and the digital filter remaining inactive (function OFF). ON: For recording and playback through the rate converter. OFF: For recording and playback with the rate converter bypassed. |
| F12–F13 | — | |

*1The data mode is operational only in the 4-channel audio versions of the 1080/59.94i and 720/59.94p system formats.

The data advance amount and data style can be set on both the AUDIO IN SETUP menu and AUDIO OUT SETUP menu. If the setting is updated on one menu, it will be updated on the other menu as well. Furthermore, these settings cannot be performed on a channel by channel basis.

*2“Dolby” and the double-D symbol DD are trademarks of Dolby Laboratories Licensing Corporation.

*3RATE CON ON/OFF function

This menu item can be set on the AUDIO OUT SET UP menu as well. When its setting is changed on one of the menus, the change will be reflected on both menus.

□ Switching the audio level meter scale



- If the audio level is adjusted below –24 dB in the FINE mode, the ↓ mark is displayed; if it is adjusted above –15 dB, the ↑ mark is displayed.

AUDIO IN SET UP menu

F11 (RATE CON) key

Operation

- The menu item is set to ON or OFF for both the recording and playback systems simultaneously: it is not possible to select the item's setting for recording or playback only.
- Similarly, the menu item is set to ON or OFF for all channels CH1 to CH8 (or CH1 to CH4) simultaneously: it is not possible to select the item's setting for specific channels only.
- If the DATA mode has been selected using F10 (STYLE) when the system format is 1080/59i 4ch or 720/59p 4ch, the DATA mode setting takes precedence. (Recording and playback are conducted with the rate converter bypassed.)

Formats supported

- The menu item is displayed and ON or OFF can be selected as its setting only with the system formats listed below.
1080/23p (psf)_8ch, 1080/25p (psf)_8ch, 1080/50i_8ch, 1080/59i_8ch,
720/59p_8ch, 1080/59i_4ch, 720/59p_4ch
- When 1080/24p(psf) 8ch has been selected as the system format, the menu display is cleared, and the rate converter is forcibly set to ON.
- When 525/59i 4ch, 525/59i 8ch or 625/50i has been selected as the system format, the menu display is cleared, and the rate converter is forcibly set to OFF.

Precautions when selecting OFF as the rate converter setting

- The video input and AES input must be synchronized.
- The video output and reference signal selected by OUT REF must be synchronized.
- During P.PLAY playback, the frequency of the digital audio output ceases to be 48 kHz, and it is no longer possible for the signals to be received by external components.
- Similarly, during frame rate conversion playback (such as when a tape recorded at a system frequency of 23 Hz is to be played back at a system frequency of 25 Hz), it is no longer possible for the signals to be received by external components.

AUDIO IN CH-MIX SELECT menu

This menu is displayed by pressing the following keys: **AUDIO IN** → **F9**

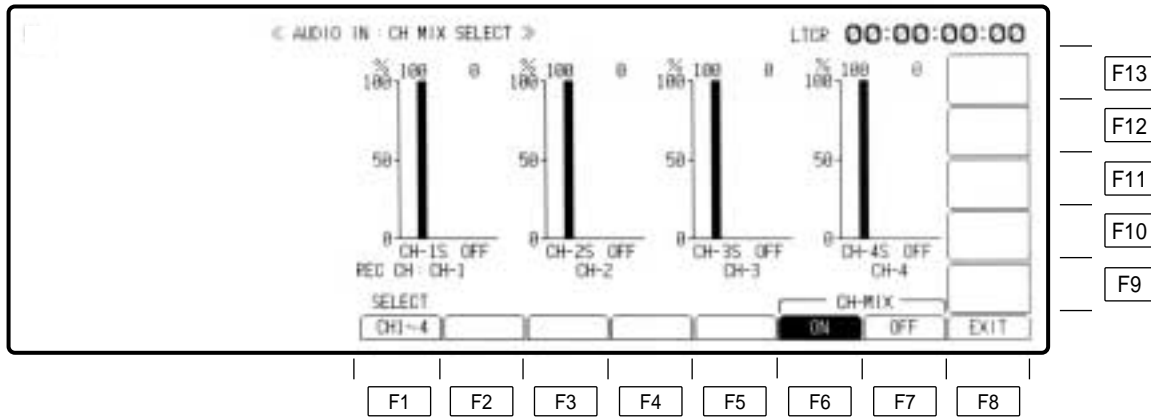

| Key | Key designation | Description |
|--------|---|--|
| F1 | SELECT | Selects the channels whose signals are to be mixed. CH1-CH4: The signals from CH1 through CH4 are selected for mixing. CH5-CH8*: The signals from CH5 through CH8 are selected for mixing. |
| F2-F5 | — | |
| F6 | CH-MIX (ON) For mixing the input signals with the signals played back simultaneously and recording them. | The signals which have been input to the digital audio channels and any two channels of the playback signals on the tape are selected and mixed at the desired ratio. ON: "ON" is selected by pressing the F6 key, and the signals can be mixed. OFF: "OFF" is selected by pressing the F7 key, and the channel signals cannot be mixed. |
| F7 | CH-MIX (OFF) For prohibiting the mixing of the input signals and signals played back simultaneously and their recording. | Even when OFF has been selected, the mixing settings set by the F6 key will still be retained. |
| F8 | EXIT | Returns the VTR to the AUDIO IN menu screen. |
| F9-F13 | — | |

*This setting is not displayed when the digital sound is in the 4-channel format.

AUDIO IN CH-MIX SELECT menu

□ Mix-and-record

- (1) Press the F6 (CH-MIX) key to set it ON.
The mixing graph display now appears.

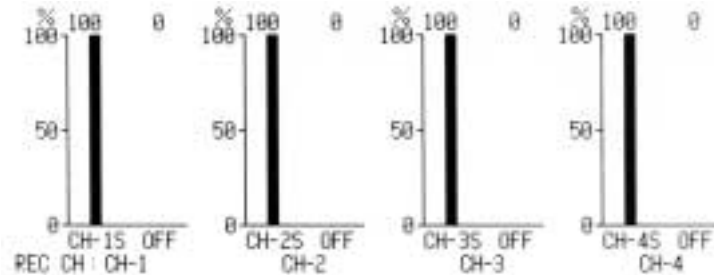
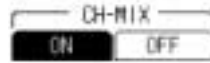

- (2) Press the center cursor key to display the cursor.

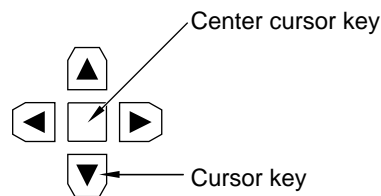

- (3) Use the cursor keys to move the cursor to the channel in which the sound is to be mixed.

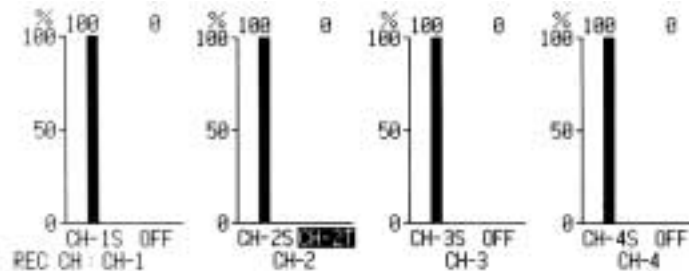

- (4) Press the center cursor key to select the signals to be mixed.

The desired signals can be set on a channel by channel basis.

The following signals can be set:

CH-1S CH-2S CH-3S CH-4S CH-5S CH-6S CH-7S CH-8S (input signals of each channel)

CH-1T CH-2T CH-3T CH-4T CH-5T CH-6T CH-7T CH-8T (play-back signals of each channel)

OFF (no mixing)

- The same signal cannot be selected for one channel.

AUDIO IN CH-MIX SELECT menu

□ Mix-and-record (continued)

- (5) Move the cursor to the mixing ratio display area, and turn the ADJUST control to set the ratio at which the signals are to be mixed (in 1% increments).

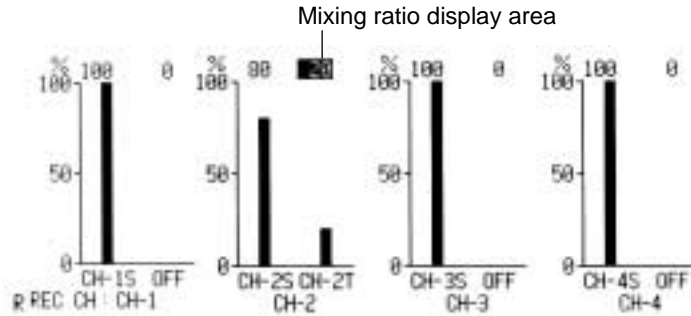

<Notes>

- When the PLAY button is pressed after the CH-MIX mode has been set, the F6 (CH-MIX) key keeps blinking. The regular playback sound is output at this time.
- When the F6 key is pressed while it is blinking, the CH-MIX sound is output. To adjust the ratio while monitoring the actual mixing sound, proceed in this status.
- To set the CH-MIX mode function to OFF, press the F7 (CH-MIX) key.

Sound output based on VTR's mode and F6, F7 key statuses

| VTR mode Key status | F6 key is lighted | F6 key is blinking | F7 key is lighted (OFF) |
|------------------------|----------------------|-----------------------|----------------------------|
| EE/STOP | CH-MIX sound | — | EE/TAPE |
| PLAY (EDIT, NORMAL) | CH-MIX sound | Playback sound | Playback sound |
| REC | CH-MIX sound | — | EE/TAPE |
| JOG/VAR/SHTL | — | Playback sound | Playback sound |

AUDIO OUT menu

This menu is displayed by pressing the following key: **AUDIO OUT**

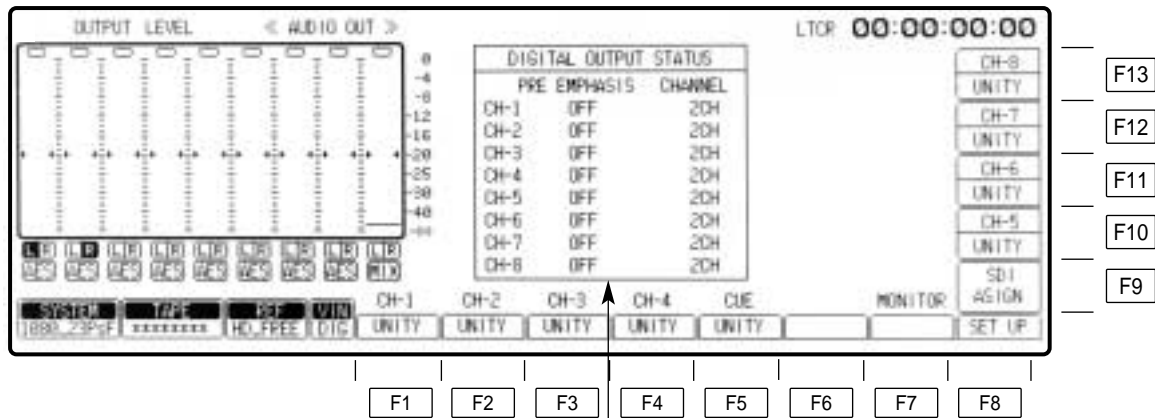

The digital audio input statuses are displayed here.

- PRE EMPHASIS ON:** Pre-emphasis is applied to the input signals.
- OFF:** Regular signals with no pre-emphasis are supplied.

AUDIO OUT menu

| Key | Key designation | Description |
|-----|--|--|
| F1 | CH-1 For adjusting the audio CH1 playback level. | |
| F2 | CH-2 For adjusting the audio CH2 playback level. | |
| F3 | CH-3 For adjusting the audio CH3 playback level. | UNITY: Input level is fixed at UNITY value. VAR: Input level can be varied with ADJUST control. ●For switchover, press the UNITY/VAR button. |
| F4 | CH-4 For adjusting the audio CH4 playback level. | |
| F5 | CUE For adjusting the cue audio playback level. | |
| F6 | — | |
| F7 | MONITOR | Transfers the VTR to the AUDIO OUT MONITOR menu screen. |
| F8 | SET UP | Transfers the VTR to the AUDIO OUT SET UP menu screen. |
| F9 | SDI ASIGN | Transfers the VTR to the AUDIO OUT SDI ASIGN menu screen. |
| F10 | CH-5 For adjusting the audio CH5 playback level. | |
| F11 | CH-6 For adjusting the audio CH6 playback level. | UNITY: Input level is fixed at UNITY value. VAR: Input level can be varied with ADJUST control. ●For switchover, press the UNITY/VAR button. |
| F12 | CH-7 For adjusting the audio CH7 playback level. | |
| F13 | CH-8 For adjusting the audio CH8 playback level. | |

AUDIO OUT MONITOR menu

This menu is displayed by pressing the following keys: **AUDIO OUT** → **F7**

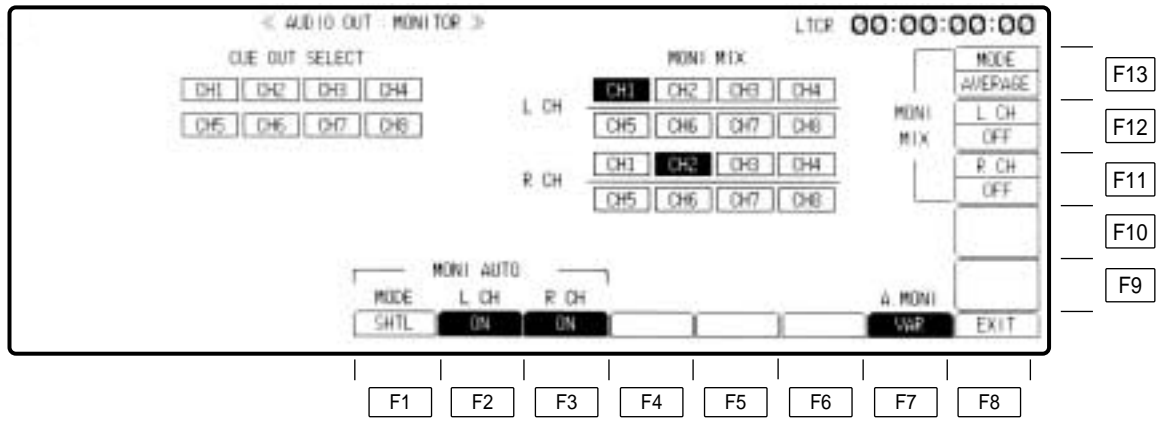

AUDIO OUT MONITOR menu

| Key | Key designation | Description |
|--------|--|---|
| F1 | MODE For selecting the mode. | Selects the VTR mode in which the monitor output signals are automatically switched to the cue signals. SHTL: Automatically outputs the playback signals of the cue channel in the SHTL, FF or REW mode. Outputs the signals of the channel selected by the L and R buttons in any other mode. VAR/SHTL: Automatically outputs the playback signals of the cue channel in the SHTL, FF, REW, JOG or VAR mode. |
| F2 | L CH | Outputs the signals of the channel selected by the L and R buttons in any other mode. Selects whether the auto mode is to be activated for the left channel. OFF: Always outputs the channel signals selected by the L button. ON: Automatically outputs the cue signals in accordance with the mode selected by F1. |
| F3 | R CH | Selects whether the auto mode is to be activated for the right channel. OFF: Always outputs the channel signals selected by the R button. ON: Automatically outputs the cue signals in accordance with the mode selected by F1. |
| F4–F6 | — | |
| F7 | A.MONI For selecting the audio monitor output level adjustment. | Selects whether to adjust the audio monitor output level using the headphones volume control on the front panel. UNITY: The audio monitor output level is forcibly fixed at the UNITY value. VAR: The level can be adjusted using the headphones volume control. |
| F8 | EXIT | Returns the VTR to the AUDIO OUT menu screen. |
| F9–F10 | — | |
| F11 | R CH | For setting whether the signals from the left and right channels are to be mixed and output to the MONITOR connector. OFF: The signals are not mixed. ON: The signals are mixed. |
| F12 | L CH | |
| F13 | MODE | For selecting the way in which the channel signals output to the MONITOR connector are to be mixed. ADD: Simple addition AVERAGE: Simple averaging |

CUE OUT SELECT

This is used to select the main line CH1 through CH4 (8) signals serving as the CUE output. When the center cursor key is pressed, CUE OUT SELECT is highlighted, enabling the setting to be selected. (If MONITOR MIX is highlighted, press the F key and a cursor key (◀ or ▶) together to enable this setting to be selected.)

Select the channel using the cursor keys (◀, ▶, ▲ and ▼), and press the center cursor key to turn the selection ON or OFF.

MONITOR MIX

This is used to select the mixed left and right channel signals to be output to the MONITOR connector. As the selection condition, not more than two channels (maximum 4 channels) among CH1 through CH4 and among CH5 through CH8 can be set to serve as the left or right channel. When the center cursor key is pressed, MONITOR MIX is highlighted, enabling the setting to be selected. (If CUE OUT SELECT is highlighted, press the F key and a cursor key (◀ or ▶) together to enable this setting to be selected.)

Select the channel using the cursor keys (◀, ▶, ▲ and ▼), and press the center cursor key to turn the selection ON or OFF. (This setting is for selecting the channels; whether or not the selected signals are to be actually set is performed by switching between the F11 and F12 keys.)

AUDIO OUT SET UP menu

This menu is displayed by pressing the following keys: **AUDIO OUT** → **F8**
 OR
SET UP → **F7**

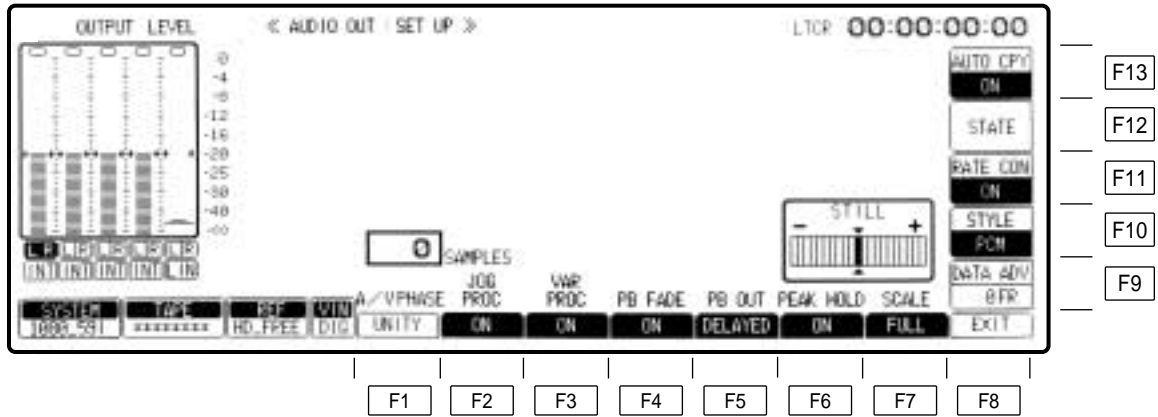

AUDIO OUT SET UP menu

| Key | Key designation | Description |
|-----|--|--|
| F1 | A/V PHASE* For adjusting the audio output phase in relation to the video phase. | When digital signals output from the unit are processed by an external unit, a phase difference between video and audio signals can be produced. Such differences can be eliminated by adjusting the audio and video signal phases. ●Refer to “Adjusting the audio output signals in relation to the video signals.” |
| F2 | JOG PROC For setting the digital process ON/OFF. | Selects the digital processing in the JOG mode. ON: Performs PCM audio digital processing. OFF: No PCM audio digital processing. |
| F3 | VAR PROC For setting the digital process ON/OFF. | Selects the digital processing in the VAR mode. ON: Performs PCM audio digital processing. OFF: No PCM audio digital processing. |
| F4 | PB FADE Playback fade. | Uses V-fade to instantaneously eliminate the audio noise occurring during playback at the cut edit points. ON: Activates the playback V-fade processing at all cut edit points on the tape. OFF: No playback V-fade processing. |
| F5 | PB OUT Selects the audio output when playback is started. | When shifting from stop to play status, some time elapses before the audio signals are output. This time lapse can be shortened. INSTANT: Shortens the time lapse before audio is output. The first part of the audio signal to be output, however, produces an incomplete sound. Use for transmission purposes is not recommended. Convenient when used for search operations, for instance, because the audio signals can be checked quickly. DELAYED: Outputs the audio signals as soon as they are complete. |
| F6 | PEAK HOLD For setting the peak hold of the level meter. | For holding the peak recording and playback levels. ON: Peak level is held. OFF: Peak level is not held. |
| F7 | SCALE For switching the level meter scale. | For switching the scale of the audio level meter on display to standard scale or fine scale. FINE: Scale in 0.2 dB increments. (–24dB to –15dB) FULL: Standard scale. (–∞ to –0dB) Refer to “Switching the audio level meter scale” in the AUDIO IN SET UP menu section (on page 56). |
| F8 | EXIT | Returns the VTR to the AUDIO OUT menu screen. |
| F9 | DATA ADV* | 0–1 Fr (in increments of 1/10th of a frame): The amount by which the data is to be advanced when the digital audio input/output format is in the data mode is adjusted. (When “0” is set, the amount is set to the default setting inside the VTR.) |

*This item does not function when the E-E through mode (refer to the description of the F2 key on the AUDIO OUT SET UP STATE menu) has been set.

AUDIO OUT SET UP menu

| Key | Key designation | Description |
|-----|------------------------|--|
| F10 | STYLE* ¹ | This menu item can be set by pressing the F10 key together with the F key. PCM: The style is set to the normal PCM audio mode. DATA: The style is set to the data mode (compressed audio: Dolby-E). |
| F11 | RATE CON* ² | This enables recording and playback to be conducted either through the rate converter in the AUDIO I/O area and with the digital filter activated (function ON) or with the rate converter bypassed and the digital filter remaining inactive (function OFF). ON: For recording and playback through the rate converter. OFF: For recording and playback with the rate converter bypassed. |
| F12 | STATE | Transfers the VTR to the AUDIO OUT SET UP STATE menu screen. (See page 70.) |
| F13 | AUTO CPY* ³ | This enables the sound of channels 1 through 4 to be output to the audio AES output and embedded audio output channels 5 through 8 even when an audio 4-channel format or 4-channel tape is to be played back. ON: The sound of channels 1 through 4 is output to channels 5 through 8. OFF: The sound is not output to channels 5 through 8. <Note> If the CH1-4 setting on the AUDIO OUT SDI ASSIGN MENU is OFF, the sound is not output to embedded audio output channels 5 through 8 even when ON has been selected as the setting of this menu item. |

*¹The data mode is operational only in the 4-channel audio versions of the 1080/59.94i and 720/59.94p system formats.

The items on this menu can also be set on the AUDIO IN SETUP menu. If the setting is updated on one menu, it will be updated on the other menu as well. Furthermore, these settings cannot be performed on a channel by channel basis.

*²RATE CON ON/OFF function

This menu item can be set on the AUDIO IN SET UP menu as well. When its setting is changed on one of the menus, the change will be reflected on both menus.

*³This item appears only when an audio 4-channel format (1080/59i, 720/59p or 480/59i) has been selected.

AUDIO OUT SET UP menu

F11 (RATE CON) key

Operation

- The menu item is set to ON or OFF for both the recording and playback systems simultaneously: it is not possible to select the item's setting for recording or playback only.
- Similarly, the menu item is set to ON or OFF for all channels CH1 to CH8 (or CH1 to CH4) simultaneously: it is not possible to select the item's setting for specific channels only.
- If the DATA mode has been selected using F10 (STYLE) when the system format is 1080/59i 4ch or 720/59p 4ch, the DATA mode setting takes precedence. (Recording and playback are conducted with the rate converter bypassed.)

Formats supported

- The menu item is displayed and ON or OFF can be selected as its setting only with the system formats listed below.
1080/23p (psf)_8ch, 1080/25p (psf)_8ch, 1080/50i_8ch, 1080/59i_8ch,
720/59p_8ch, 1080/59i_4ch, 720/59p_4ch
- When 1080/24p(psf) 8ch has been selected as the system format, the menu display is cleared, and the rate converter is forcibly set to ON.
- When 525/59i 4ch, 525/59i 8ch or 625/50i has been selected as the system format, the menu display is cleared, and the rate converter is forcibly set to OFF.

Precautions when selecting OFF as the rate converter setting

- The video input and AES input must be synchronized.
- The video output and reference signal selected by OUT REF must be synchronized.
- During P.PLAY playback, the frequency of the digital audio output ceases to be 48 kHz, and it is no longer possible for the signals to be received by external components.
- Similarly, during frame rate conversion playback (such as when a tape recorded at a system frequency of 23 Hz is to be played back at a system frequency of 25 Hz), it is no longer possible for the signals to be received by external components.

AUDIO OUT SET UP menu

□ Adjusting the audio output signals in relation to the video signals

(1) Press the F1 (A/V PHASE) key to put the display in reverse video.

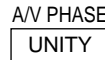

(2) Adjust the phase difference using the ADJUST control.

When the ADJUST control is turned, the display changes to VAR.

(The adjustment can now be varied in 1-sample increments from +16 to -96 samples.)

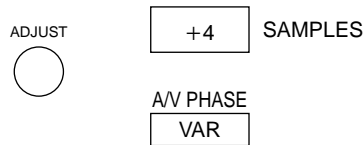

(3) Upon completion of the adjustment, press the F1 (A/V PHASE) key.

- When the UNITY/VAR key is pressed during the adjustment, the UNITY mode is restored. When the key is pressed again, the mode reverts to VAR.



□ Fade function

During editing, the cut-edited data is recorded automatically; during playback, this data is detected and the section concerned is V-faded.

Playback V-fade function OFF

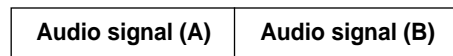

Noise appears at the joins in the editing.

Playback V-fade function ON



V-fading is performed for an instant to eliminate the noise.

AUDIO OUT SET UP STATE menu

This menu is displayed by pressing the following keys: **AUDIO OUT** → **F8** → **F12**

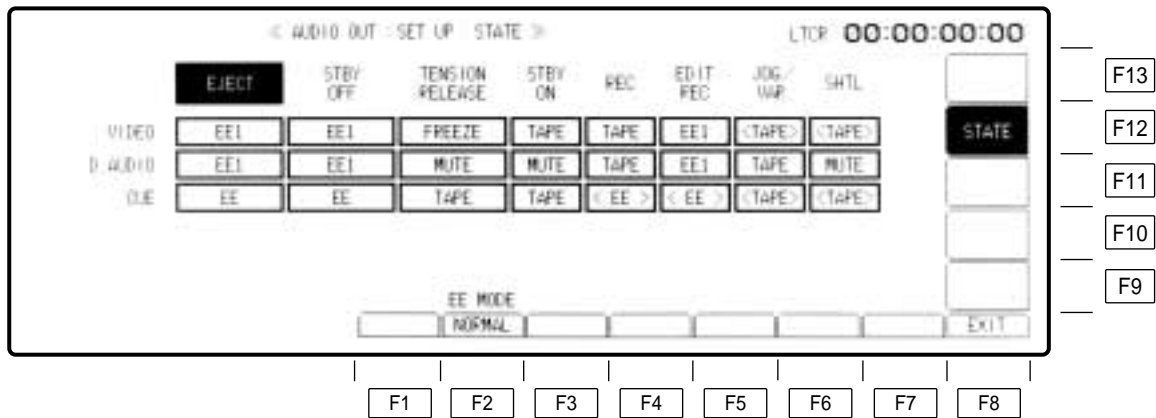

| Key | Key designation | Description |
|--------|-----------------|--|
| F1 | — | |
| F2 | EE_MODE | <p>NORMAL: The standard mode is established (E-E through mode is turned OFF).</p> <p>THROUGH: The E-E through mode (AV minimum delay mode) is established.</p> <p>*A discrepancy occurs between the video (audio) output and time code output in the E-E through mode.</p> |
| F3–F7 | — | |
| F8 | EXIT | Transfers the VTR to the AUDIO OUT SET UP menu screen. |
| F9–F13 | — | |

VIDEO OUT SET UP STATE menu

□ Selecting the TAPE/EE output signals

The video, audio and cue signals which are output during the VTR's operation are switched on this menu to TAPE or EE signals.

- (1) Press the center cursor key to display the cursor.

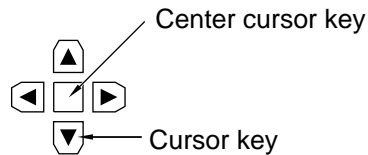

- (2) Move the cursor to the desired position using the cursor keys.
 •The cursor will not move to places which cannot be set.



- (3) Press the center cursor key to select TAPE or EE.
 Refer to the following table for the types of setting options.

| Mode CH | EJECT | STBY OFF | TENSION RELEASE | STBY ON | REC | EDIT REC | JOG/ VAR | SHTL |
|------------|---|---|---|---------------------------|---------------------------|--------------------|---------------------|---------------------|
| VIDEO | FREEZE BLACK GRAY FREE NOISE <u>EE1</u> EE2 | FREEZE BLACK GRAY FREE NOISE <u>EE1</u> EE2 | <u>FREEZE</u> BLACK GRAY FREE NOISE EE1 EE2 | <u>TAPE</u> EE1 EE2 | <u>TAPE</u> EE1 EE2 | TAPE <u>EE1</u> | TAPE | TAPE |
| D.AUDIO | MUTE <u>EE1</u> EE2 | MUTE <u>EE1</u> EE2 | <u>MUTE</u> EE1 EE2 | <u>MUTE</u> EE1 EE2 | <u>TAPE</u> EE1 EE2 | TAPE <u>EE1</u> | <u>TAPE</u> MUTE | TAPE <u>MUTE</u> |
| CUE | TAPE <u>EE</u> | TAPE <u>EE</u> | <u>TAPE</u> EE | <u>TAPE</u> EE | EE | EE | TAPE | TAPE |

(Underline denotes the factory setting mode.)

- When a setting is to be established during head selection using the TEST menu or during editing, the setting applying to the operation concerned takes precedence over the setting selected using the VIDEO OUT SET UP STATE menu.
- When TAPE/EE has been set by F1 (OUTPUT) on the HOME menu, the HOME menu setting takes precedence.

AUDIO OUT SDI ASSIGN menu

This menu is displayed by pressing the following keys: **AUDIO OUT** → **F9**

The screenshot displays the 'AUDIO OUT SDI ASSIGN' menu. At the top left, there is an 'OUTPUT LEVEL' meter with a scale from 0 to -60 dB. The title is '<< AUDIO OUT : SDI ASSIGN >>' and the LTPR is '00:00:00:00'. The menu is divided into several sections:

- Signal Flow Diagrams:**
 - Top diagram: HD and SD inputs connect to HD_TO_HD and SD_TO_HD, which then connect to HD and SD outputs.
 - Bottom diagram: HD and SD inputs connect to HD_TO_HD and SD_TO_HD, which then connect to HD and SD outputs.
- Channel Assignment Options:**
 - SD_TO_SD:** CH1~4, CH1~4, CH5~8, CH5~8
 - SD_TO_HD:** CH1~4, CH1~4, CH5~8, CH5~8
 - SD_AUD:** OFF, 24bit
 - EXIT:** EXIT
- Bottom Navigation:**
 - SYSTEM:** 1080i_50i
 - TYPE:** *****
 - REF:** HD_FPGA
 - VIEW:** DTG
 - HD_TO_HD:** CH1~4, CH5~8
 - HD_TO_SD:** CH1~4, CH5~8
 - F1-F8:** F1, F2, F3, F4, F5, F6, F7, F8

Navigation keys are indicated on the right side of the screen: F13, F12, F11, F10, and F9.

AUDIO OUT SDI ASIGN menu

| Key | Key designation | Description |
|-----|--------------------|--|
| F1 | HD_TO_HD CH1-4 | Selects the channels whose signals are to be output to HD SDI embedded audio channels 1 through 4. CH1-4: The signals of CH1 through CH4 are output. CH5-8: The signals of CH5 through CH8 are output. OFF: No signals are output. |
| F2 | HD_TO_HD CH5-8* | Selects the channels whose signals are to be output to HD SDI embedded audio channels 5 through 8. CH1-4: The signals of CH1 through CH4 are output. CH5-8: The signals of CH5 through CH8 are output. OFF: No signals are output. |
| F3 | — | |
| F4 | HD_TO_SD CH1-4 | Selects the channels whose signals are to be output to SD SDI embedded audio channels 1 through 4. CH1-4: The signals of CH1 through CH4 are output. CH5-8: The signals of CH5 through CH8 are output. OFF: No signals are output. |
| F5 | HD_TO_SD CH5-8* | Selects the channels whose signals are to be output to SD SDI embedded audio channels 1 through 4. CH1-4: The signals of CH1 through CH4 are output. CH5-8: The signals of CH5 through CH8 are output. OFF: No signals are output. |
| F6 | SD_AUD | This is used to select either 20 bit or 24 bit for SD_SDI embedded audio output. 24 bit: 24 bit output is selected. 20 bit: 20 bit output is selected. |
| F7 | — | |
| F8 | EXIT | Returns the VTR to the AUDIO OUT menu screen. |
| F9 | SD_TO_HD CH5-8* | Selects the channels whose signals are to be output to HD SDI embedded audio channels 5 through 8. CH1-4: The signals of CH1 through CH4 are output. CH5-8: The signals of CH5 through CH8 are output. OFF: No signals are output. |
| F10 | SD_TO_HD CH1-4 | Selects the channels whose signals are to be output to HD SDI embedded audio channels 1 through 4. CH1-4: The signals of CH1 through CH4 are output. CH5-8: The signals of CH5 through CH8 are output. OFF: No signals are output. |
| F11 | — | |
| F12 | SD_TO_SD CH5-8* | Selects the channels whose signals are to be output to SD SDI embedded audio channels 1 through 4. CH1-4: The signals of CH1 through CH4 are output. CH5-8: The signals of CH5 through CH8 are output. OFF: No signals are output. |
| F13 | SD_TO_SD CH1-4 | Selects the channels whose signals are to be output to SD SDI embedded audio channels 1 through 4. CH1-4: The signals of CH1 through CH4 are output. CH5-8: The signals of CH5 through CH8 are output. OFF: No signals are output. |

*This setting is not displayed when the digital sound is in the 4-channel format.

TC/CHR menu

This menu is displayed by pressing the following key: TC/CHR

The screenshot shows the TC/CHR menu interface with the following elements:

- OUTPUT LEVEL**: A graph with 8 vertical bars and a y-axis from 0 to -40.
- « TC/CHR »**: The menu title.
- SUPER POSITION**: A large empty rectangular area.
- LTDR 00:00:00:00**: A digital counter.
- CHR TYPE**: A vertical list of options: REVERSE, EX SUPER, ERR/FMT, SUPER, TC ST, TCR, AUTO, CONVERT.
- Function Key Callouts**:
 - F13: Points to the top of the CHR TYPE list.
 - F12: Points to the REVERSE option.
 - F11: Points to the SUPER option.
 - F10: Points to the TCR option.
 - F9: Points to the CONVERT option.
- Bottom Status Bar**:

| | | | | | | | | | | |
|------------|-------|--------|-----|--------|------|-------|-----|-------|-----|----|
| SYSTEM | TYPE | REF | WIN | SOURCE | TC | SLAVE | LB | SLAVE | RUN | MD |
| 1000 23:52 | ***** | HD PRG | DIS | INT | AUTO | OFF | REC | RUN | | |
- Bottom Function Keys**: A row of keys labeled F1 through F8.

TC/CHR menu

| Key | Key designation | Description |
|-----|---|--|
| F1 | SOURCE For selecting internal/external time code signal. | <p>INT: Built-in time code generator.</p> <p>EXT LTC: LTC time code from TIME CODE input connector.</p> <p>S LTC: LTC time code added to serial signals; not displayed when the SD mode is selected.</p> <p>S VTC: VTC time code added to serial signals; not displayed when the SD mode is selected.</p> <p>EXT VITC: VITC time code added to video signals; not displayed when the HD mode is selected.</p> |
| F2 | TC SLAVE For setting up time code slave lock mode. | <p>●When the F1 (SOURCE) key is at [INT], AUTO, PRESET and SALVE are displayed.</p> <p>AUTO: Generator locks at the value read out by the reader. In this case there is no time code setting. (Only during editing.) During normal recording, however, any setting of the generator can be performed.</p> <p>PRESET: Generator does not lock at the value read out by the reader. Generator can be set freely.</p> <p>SLAVE: The generator is locked to the reader's readout value. In this case, the time code cannot be set.</p> <hr/> <p>●When the F1 (SOURCE) key is at [TEXT LTC], SALVE and DIRECT are displayed.</p> <p>SLAVE: Generator locks to external LTC time code. (When there is no external input, E-TC time data blinks.)</p> <p>DIRECT: External LTC time code is recorded as is. (When there is no external input, E-TC: *:*:* *: *:*:* * are displayed.)</p> <hr/> <p>●When the F1 key is at [S VITC], [S LTC] or [EXT VITC], this key is not displayed. In this case, the generator value typically locks to external VITC or LTC time code.</p> |
| F3 | UB SLAVE User bit lock. | <p>ON: User bit locks to user bit value read by reader (TCR) or to external user bit value, and cannot be set.</p> <p>OFF: Generator does not lock to value read out by reader. User bit value can be set freely.</p> |
| F4 | RUN MD Time code progress. | <p>REC RUN: Runs the TC only while recording is in progress.</p> <p>FREE RUN: Runs the TC all the time in the same way as a clock.</p> |
| F5 | DF MD* For selecting drop or non-drop frame. | <p>Valid only when the F1 (SOURCE) key selects [INT].</p> <p>ON: Drop frame mode is set.</p> <p>OFF: Non-drop frame mode is set.</p> <p>●When [EXT LTC], [S VITC] or [S LTC] is selected in the F1 key, the VTR conforms to drop/non-drop frame mode of external time code.</p> |

*This is not displayed when the 1080/23psf, 1080/23p, 1080/24psf, 1080/24p, 1080/25psf, 1080/25p, 1080/50i or 576/50i system format has been selected.

TC/CHR menu

| Key | Key designation | Description |
|-----|--|--|
| F6 | CF BIT* ¹ For selecting the color frame bit ON/OFF during recording. | ON: CF BIT is recorded. OFF: CF BIT is not recorded. ●When [EXT LTC], [S VITC] or [S LTC] is selected in the F1 key, the VTR conforms to the external color frame bit. |
| F7 | — | |
| F8 | SETUP | Transfers the VTR to the TC/CHR SET UP menu screen. |
| F9 | CONVERT* ² | Transfers the VTR to the TC/CHR CONVERT menu screen. |
| F10 | TCR For selecting time code read out mode. | LTC: LTC is read out all the time. AUTO: At low speed, VITC is read preferentially. When it is not read, then LTC is read. VITC: VITC is read out all the time. ●In either setting, when the time code cannot be read, values corrected by control signal are read out. (Interpolation mode is assumed and [INTRP] is displayed on the HOME menu.) |
| F11 | SUPER For setting superimpose. | TC.ST: The time code and VTR operating mode are superimposed. TC.ST.RT: The time code, VTR operating mode and remaining tape time are superimposed. TC.UB: The time code and user's bit are superimposed. TC.TC: The time code is displayed in two steps. Both the original time code information and the time code information in the format to which it has been converted can be displayed at the same time. (Refer to the note on the next page.) TC: Only the time code is superimposed. OFF: Nothing is superimposed. |
| F12 | EX SUPER | ERR/FMT: When there are warnings, warning displays appear. When there are no warnings, the system format and tape format frequencies are displayed. ERR: The warning displays or format information are superimposed onto the screen. OFF: The warning displays or format information are not superimposed. |
| F13 | CHR TYPE For selecting type of character to be superimposed. | REVERSE: Characters appear against a black background. INTENSE: Characters are displayed more intensely. |

*¹This is displayed only when the 480/59.94i or 576/50i system format has been selected.

*²This is displayed only when the 1080/23psf, 1080/23p, 1080/24psf, 1080/24p, 1080/25psf, 1080/25p or 1080/50i system format has been selected.

TC/CHR menu

□ Changing the superimposing position



(1) Move the position using the cursor keys.

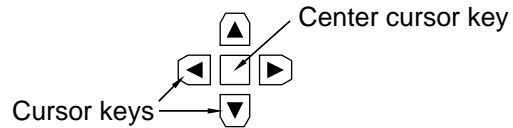

- When a cursor key is held down, the cursor will move more quickly.
- When the center cursor key is pressed, the superimposing returns to its initial position.

□ Time code displays and VTR's operating modes

Display the time codes and VTR's operating modes as required.

Time code displays

CTL1: Control signal 1

CTL2: Control signal 2

LTCR: LTC time code readout value

LUBR: LTC user bit readout value

VTCR: VITC time code readout value

VUBR: VITC user bit readout value

TCG: Value generated by time code generator

LUBG: Value of LTC user bit generated

VUBG: Value of VITC user bit generated

EXTC: External time code value

EXUB: External user bit value

- The colon (":") between the seconds and frames denotes the readout mode of the time code reader.

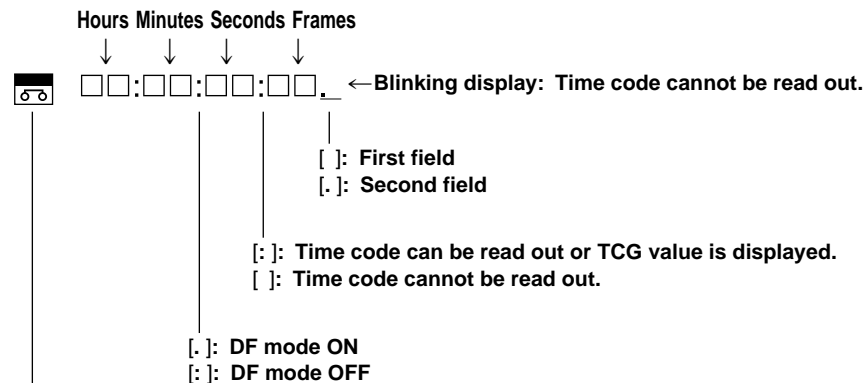

This indicates that the time code is the original time code which was recorded on the tape. If the time code displayed is not accompanied by this cassette mark, it means that the time code is the post-conversion time code. (This display will go off when setting the CTL or UB.)

TC/CHR menu

□ Time code displays and VTR's operating modes (continued)

VTR's operating modes

| | |
|---|--|
| STOP | F.FWD |
| PREVIEW | REW |
| REVIEW | EDIT PLAY (edit playback) |
| PREROLL | EDIT REC (edit recording) |
| AUTO EDIT (automatic editing) | CUE UP |
| JOG | STANDBY OFF |
| VAR | EJECT |
| SHTL | DMC PREVIEW |
| REC | DMC EDIT |
| REC | |
| (display blinks during Pre-CTL operation) | OUT PREVIEW |
| PLAY | DMC SAMPLE |
| | (variable memory speed sampling underway) |
| P PLY (programmed playback) | DMC PLAY (variable memory playback underway) |
| TSO (TAPE SPEED OVERRIDE) | AUTO OFF |

- In the shuttle/variable mode and CUE UP and PREROLL modes, the tape travel direction is indicated as "+" or "-", and the tape speed is displayed as an integer.
- In the jog mode, the tape travel is indicated by "<" when it is moving in the forward direction, by "*" when it has stopped, and by ">" when it is moving in the reverse direction.
- In the programmed playback and TSO modes, "+" or "-" is used to indicate the deviation direction, and the deviation data is displayed as a percentage.

□ Error information displays

Press the F12 (EX SUPER) key and set the display to ERR/FMT or ERR.

The error information will now be displayed.

| | |
|---|--|
| FAN STOP (fan stopped) | HD REF ERROR (no HD reference signal input) |
| ERASE ERROR (erase current stopped) | SD REF ERROR (no SD reference signal input) |
| COMP.CPU ERROR | HD SDI ERROR (HD SDI signal error) |
| (error in communication with CPU) | |
| CONCEAL SW OFF | SD SDI ERROR (SD SDI signal error) |
| (conceal SW at "OFF" position) | |
| ECC SW OFF (ECC SW at "OFF" position) | FREQ UNMATCH (frequency settings fail to match) |
| SERVO UNLOCK (no servo lock) | VIDEO ERROR (video system error) |
| CTL NOT DET. (no CTL signal detection) | PCM ERROR (PCM signal system error) |
| LOW RF (drop in RF level during recording) | RS-422 ERROR (RS-422 system error) |
| CONCEAL V/A (video/audio error corrected) | RS-232C ERROR (RS-232C system error) |
| CONCEAL A (audio error corrected) | VA-CONT ERROR (VA controller error) |
| CONCEAL V (video error corrected) | TC ERROR (time code error occurred) |
| AUDIO MUTE (audio output muted) | CARD LOW BATT (low charge in front IC card battery) |
| HIGH ERROR (inner error value too high) | SYSCON ERROR (system control system error occurred) |
| CTL HEAD CLOG (CTL head clogged) | MECHA ERROR (mechanical system error occurred) |
| LTC HEAD CLOG (LTC head clogged) | SERVO ERROR (reel, drum or capstan error occurred) |
| OPT ERROR (optimization system error) | SYSTEM ERROR (other error) |

TC/CHR menu

□ Superimposed displays

When TC.TC is selected as the SUPER setting, the time code appears as a 2-level display. (The HD SUPER and SD SUPER are linked.) The converted time code is displayed on the top level of the superimposed display. On the bottom level, the display can be switched between the original time code recorded on the tape and the converted time code.

Depending on the settings of the F11 and F12 keys on the TC/CHR CONVERT menu, the display patterns are as shown below.

| System frequency | | 24 (23.98) | | | | | | | | |
|-----------------------|--------------|------------|--------|--------|---------|----------|--------|----------|----------|----------|
| TAPE | | 24 (23.98) | | | 25p/50i | | | 59 (60) | | |
| MENU SUPER (F11, F12) | | 24 | 25 | 30 | 24 | 25 | 30 | 24 | 25 | 30 |
| 1-level display | | 24LTCR C | 25LTCR | 30LTCR | 24LTCR | 25LTCR C | 30LTCR | 24LTCR | 25LTCR C | 30LTCR C |
| 2-level display | Top level | 30LTCR | 30LTCR | 30LTCR | 30LTCR | 30LTCR | 30LTCR | 30LTCR C | 30LTCR C | 30LTCR C |
| | Bottom level | 24LTCR C | 25LTCR | 30LTCR | 24LTCR | 25LTCR C | 30LTCR | 24LTCR | 25LTCR | 30LTCR C |

| System frequency | | 25 | | | | | |
|-----------------------|--------------|------------|--------|----------|----------|---------|--------|
| TAPE | | 24 (23.98) | | 25p/50i | | 59 (60) | |
| MENU SUPER (F11, F12) | | 24 | 25 | 24 | 25 | 24 | 25 |
| 1-level display | | 24LTCR C | 25LTCR | 24LTCR | 25LTCR C | 24LTCR | 25LTCR |
| 2-level display | Top level | 25LTCR | 25LTCR | 25LTCR C | 25LTCR C | 25LTCR | 25LTCR |
| | Bottom level | 24LTCR C | 25LTCR | 24LTCR | 25LTCR C | 24LTCR | 25LTCR |

“C” is the cassette mark.

□ Superimposed displays of format information

When the F12 (EX SUPER) key is pressed and set to ERR/FMT, the display of the following information can be superimposed. The information relating to the format appears on the top-most level of the superimposed display.

SYS: The frequency information of the SYSTEM format is displayed. For example, “23” is displayed when the 1080/23psf format has been set.

TAPE: The frequency information of the format played back on the tape is displayed. For example, “24” is displayed during playback when the tape has been recorded using the 1080/24psf format.

If the tape format is unspecified, “* *” appears.

(When an error has occurred, the error display takes precedence over the format so that the format is not displayed.)

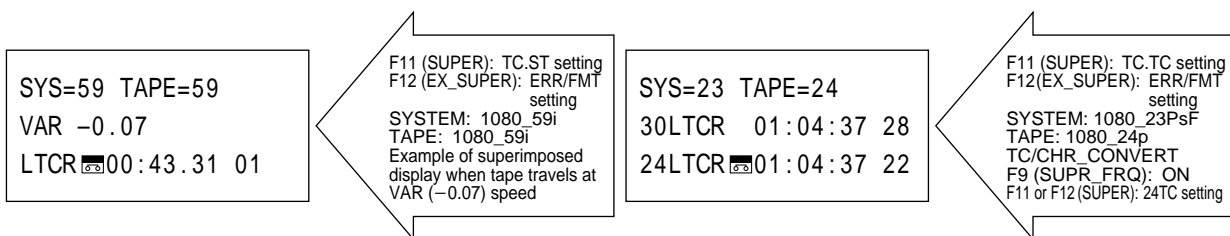

TC/CHR menu

Table of user bit settings

| F1 (SOURCE) | F2 (TC SLAVE) | F3 (UB SLAVE) | F10 (TCR) | LUBG mode | VUBG mode | | |
|-------------------|---------------|---------------|-----------|-----------|-----------|--------|--------|
| INT (internal) TC | --- | ON | LTC | REGEN | INT UB | | |
| | | | AUTO | | REGEN | | |
| | | | VITC | INT UB | | | |
| | | OFF | --- | LTC | PRESET | INT UB | |
| | | | | AUTO | | PRESET | |
| | | | | VITC | INT UB | | |
| S LTC S VITC | --- | ON | LTC | EXT REGEN | INT UB | | |
| | | | AUTO | | EXT REGEN | | |
| | | | VITC | INT UB | | | |
| | | EXT LTC | SLAVE | OFF | LTC | PRESET | INT UB |
| | | | | | AUTO | | PRESET |
| | | | | | VITC | INT UB | |
| EXT LTC | DIRECT | ON | LTC | DIRECT | INT UB | | |
| | | | AUTO | | EXT REGEN | | |
| | | | VITC | | INT UB | | |
| | | OFF | LTC | | INT UB | | |
| | | | AUDIO | | PRESET* | | |
| | | | VITC | | PRESET* | | |

*The user bit can be set in all modes except for recording.

- DIRECT:** The external LTC input signal is recorded directly and output. It is not synchronized with the internal reference signal.
- REGEN:** The user bit is slave-locked to the value read out on the tape. The user bit cannot be set.
- EXT REGEN:** The user bit is slave-locked to the externally input VITC or LTC. The user bit cannot be set.
- PRESET:** The user bit is not locked to the value read out on the tape or external input. The user bit can be set.
- INT UB:** In this mode, the previous user bit is retained, and neither the REGEN nor PRESET functions can be implemented.
To set the user bit again, use the F1 (SOURCE), F2 (TC SLAVE) or F3 (UB SLAVE) key to select one of the three modes above.

TC/CHR SET UP menu

This menu is displayed by pressing the following keys: **TC/CHR** → **F8**
OR
SET UP → **F5**

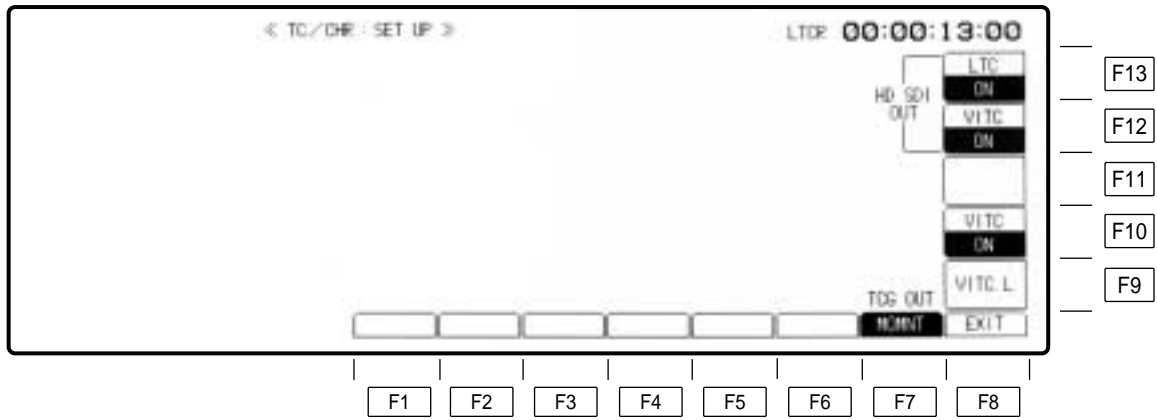

TC/CHR SET UP menu

| Key | Key designation | Description |
|-------|--|--|
| F1–F6 | | |
| F7 | TCG OUT | <p>For selecting whether to latch the TCG display and LTC output using the INPUT CHECK key*.</p> <p>MOMNT: Establishes the INPUT CHECK mode only while the key is held down.</p> <p>LATCH: The INPUT CHECK mode is established when the INPUT CHECK key is pressed, and it is held even when the key is released. The mode is released in a mode other than the EJECT, STBY ON/OFF or STOP mode or when the F1 (OUTPUT) key on the HOME menu is pressed.</p> |
| F8 | EXIT | Returns the VTR to the TC/CHR menu screen. |
| F9 | VITC.L | <p>For transferring to the VITC LINE selection menu.</p> <p>SD mode: The recording VITC superimposing and the lines in which it is superimposed are set. The playback VITC superimposing and the lines in which it is superimposed are set.</p> <p>HD mode: The DOWN CON SD output VITC superimposing and the lines in which it is superimposed are set.</p> |
| F10 | VITC For superimposing VITC onto the SD output. | <p>For selecting whether the VITC information is to be superimposed on SD recording and output.</p> <p>ON: VITC is superimposed.</p> <p>OFF: VITC is not superimposed.</p> |
| F11 | — | |
| F12 | VITC For selecting the VITC. | <p>For selecting whether the VITC information is to be carried on the HD SDI output.</p> <p>Selects whether the VITC is to be carried.</p> <p>ON: VITC is carried.</p> <p>OFF: VITC is not carried.</p> |
| F13 | LTC For selecting the LTC. | <p>For selecting whether the LTC information is to be carried on the HD SDI output.</p> <p>Selects whether the LTC is to be carried.</p> <p>ON: LTC is carried.</p> <p>OFF: LTC is not carried.</p> |

| |
|--|
| NTSC: 10–20 lines (Default 14, 15) PAL: 8–22 lines (Default 11, 13) |
|--|

*The video input signals can be checked at the SD SDI MONITOR OUT or HD SDI MONITOR OUT connector, and the audio input signals can be checked at the MONITOR connector and HEADPHONES jack; these signals are switched to the input signals while the INPUT CHECK key is held down.

TC/CHR SET UP VITC.L menu

This menu is displayed by pressing the following keys: **TC/CHR** → **F8** → **F9**
 OR
SET UP → **F5** → **F9**.

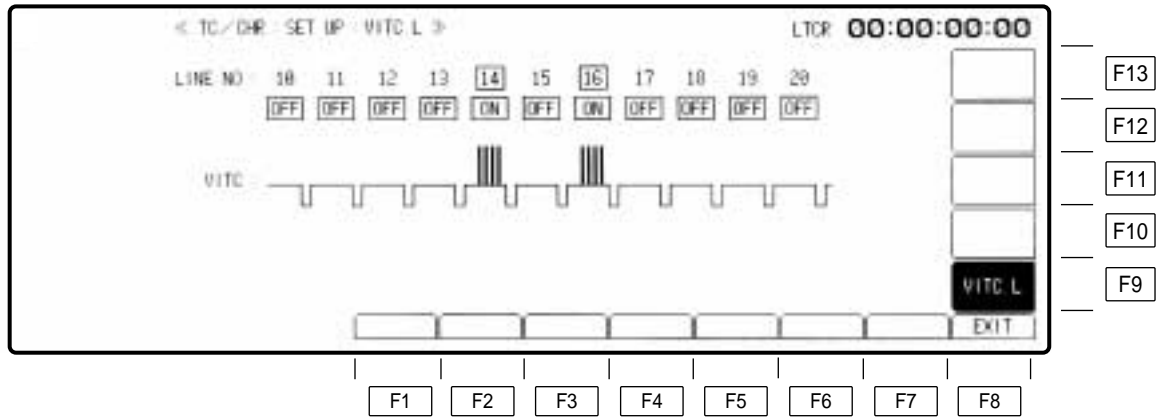

| Key | Key designation | Description |
|---------|-----------------|--|
| F1-F7 | — | |
| F8 | EXIT | Returns the VTR to the TC/CHR menu screen. |
| F9 | VITC.L | <p>SD mode: The superimposing of the recording VITC and the lines where it is to be superimposed are set. The superimposing of the playback VITC and the lines where it is to be superimposed are set.</p> <p>HD mode: The superimposing of the DOWN CON SD output VITC and the lines where it is to be superimposed are set.</p> |
| F10-F13 | — | |

TC/CHR SET UP VITC.L menu

□ Selecting the line where VITC is to be inserted

1. Use the cursor keys (◀, ▶) to select the lines where VITC is to be inserted.

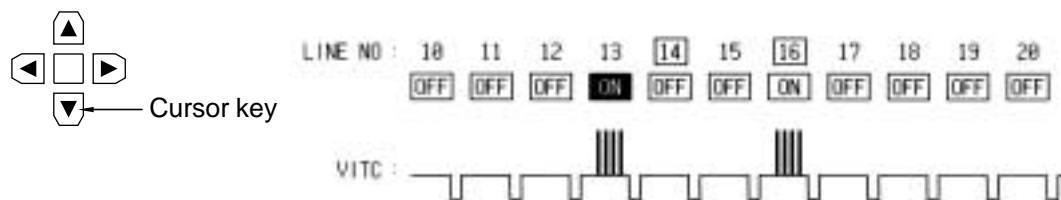

The line numbers shown in the boxes on the screen indicate the recommended insertion lines (lines 14 and 16 for NTSC and lines 11 and 13 for PAL).

2. To select other lines, press the center cursor key.
(Up to two lines can be selected for insertion.)

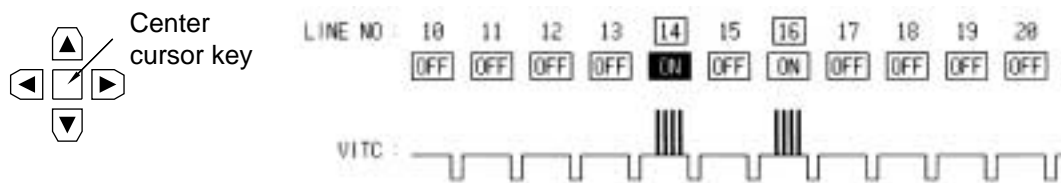

TC/CHR CONVERT menu

This menu is displayed by pressing the following keys: **TC/CHR** → **F9**

□ 2-level and 3-level time code displays

● Front panel

When the 24→30 mode has been selected by the F1 (MODE) key on the TC/CHR CONVERT menu, a 2-level display appears with the original time code displayed on the top level and the converted time code displayed on the bottom level.

When the 25→30 mode has been selected, a 3-level display appears with the converted value displayed on the middle and bottom levels.

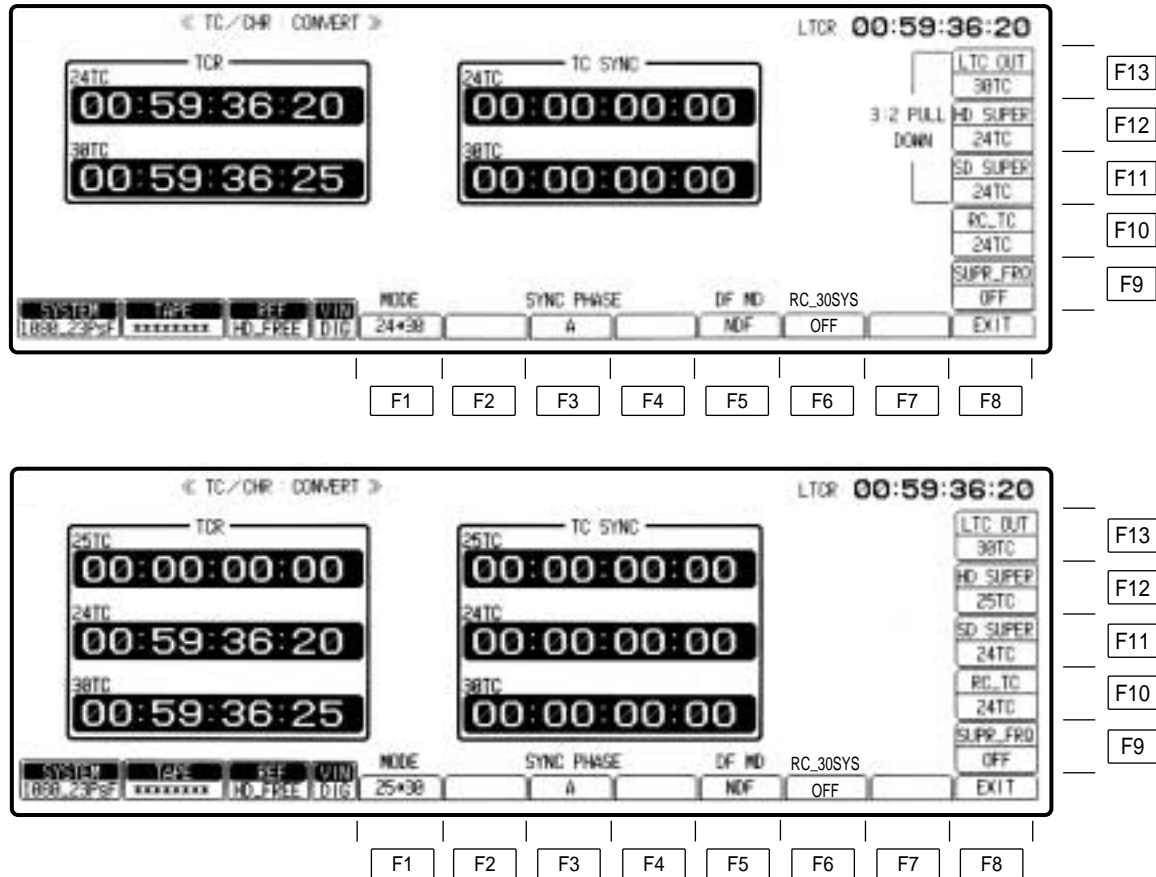

<Note>

When 24→30 is selected by the F1 (MODE) key and a 24 format tape is used, TCR 25TC will appear as “*:*:*:*:*:*”.

TC_SYNC point setting

When the center cursor key is pressed, the 24TC display is highlighted. To enter the time code, use the number keys and cursor keys (◀, ▶) to set the time code, and then press the **[ENT]** key. Move on to the 30TC/25TC value setting using the cursor keys (▲, ▼), and proceed in the same way to set and enter the time code.

| Key | Key designation | Description |
|-----|-----------------|--|
| F1 | MODE | For selecting the time code format conversion mode. 24→30: The original 24-frame count display and 30-frame count display mode is established. (Window: 24TC/30TC display) 25→30: The original 25-frame count display and 24- and 30-frame count display mode is established. (Window: 24TC/25TC/30TC display) |
| F2 | — | |

TC/CHR CONVERT menu

| Key | Key designation | Description |
|-----|-----------------|--|
| F3 | SYNC PHASE* | For setting the reference for the 3:2 conversion sequence. A: Frame A is used as the reference to convert the time code. B: Frame B is used as the reference to convert the time code. C: Frame C is used as the reference to convert the time code. D: Frame D is used as the reference to convert the time code. |
| F4 | — | |
| F5 | DF MD | For selecting whether the 3:2 pull-down output from the 1080/23psf (p) or 1080/24psf (p) format after it is converted into the time code and output is to be in the drop frame or non-drop frame mode. DF: The output will be in the drop frame mode. NDF: The output will be in the non-drop frame mode. |
| F6 | RC_30SYS | F6 (RC_30SYS) key appears when the 23.98 Hz has been selected as the VTR system frequency. Sets the 30 system edit mode with system format 24. ON: 30 system editing OFF: 24 system editing |
| F7 | 24 TAPE LTC_OUT | F7 (24 TAPE LTC_OUT) key appears when the 25/50 Hz has been selected as the VTR system frequency. Sets the LTC OUT output (during 24 tape playback with 25 system). ON: LTC output according to tape format (24 tape TC) OFF: 25 TC output |
| F8 | EXIT | Returns the VTR to the TC/CHR menu screen. |
| F9 | SUPR_FRQ | For selecting whether to add the frequency information on the time code superimposed display. ON: The frequency information is added. Example: 24LTCR OFF: The frequency information is not added. Example: LTCR |
| F10 | RC_TC* | For selecting the time code which is to be output to the remote connectors (RS-422, etc.). 24TC: The original time code with the frame count of 24 is output. 30TC: The post-conversion time code with the frame count of 30 is output. |
| F11 | SD SUPER | For selecting the time code which is to be output to the SD monitor connector. 24TC: The original time code with the frame count of 24 is output. 30TC: The post-conversion time code with the frame count of 30 is output. (25TC): The post-conversion time code with the frame count of 25 is output. |

TC/CHR CONVERT menu

| Key | Key designation | Description |
|-----|-----------------|---|
| F12 | HD SUPER | For selecting the time code which is to be output to the HD monitor connector. 24TC: The original time code with the frame count of 24 is output. 30TC: The post-conversion time code with the frame count of 30 is output. (25TC): The post-conversion time code with the frame count of 25 is output. |
| F13 | LTC OUT* | For selecting the time code which is to be output to the LTC output connector. (For details, refer to page 90.) (25TC): This item appears only when the 25/50 Hz has been selected as the system frequency. 30TC: The post-conversion time code with the frame count of 30 is output. 24TC: The time code with the frame count of 24 is output. |

*This item appears only when the 1080/23p, 1080/24p, 1080/50p or 1080/50i system format is used. When 30TC is selected as the setting, the continuity of the time code is guaranteed only in the 1× tape travel servo lock status. Bear in mind that the time code will be discontinuous at all other times.

When the audio insert editing status has been established by selecting ON as the setting for the F6 (RC_30SYS) key and 30TC for the F10 (RC_TC) key, **RC 30SYS** will appear at the top right of the HOME menu and MANUAL EDIT menu, as shown below.

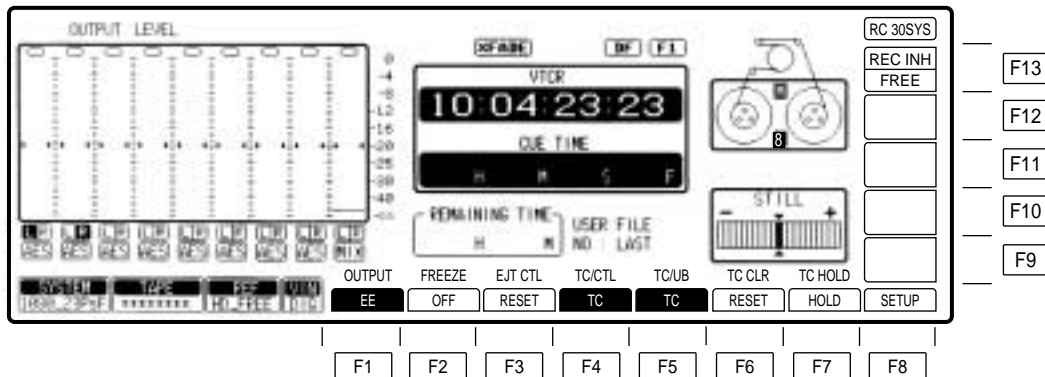

□ Concerning the TC SYNC value and sync phase settings

Since the TC is similarly converted when the 1080/23psf (p) or 1080/24psf (p) format is converted into the 1080/59i (480/59i) or 1080/60i format, it is necessary to input the time information (TC SYNC value) that will serve as the reference for conversion and the 3:2 pull-down sequence (sync phase) of the post-conversion output images.

□ Setting the TC SYNC value

Input the pre-conversion TC with the frame count of 24 (24TC) and the post-conversion TC with the frame count of 30 (30TC)/25 (25TC) to serve as the reference for conversion.

<Note>

When converting from 1080/25psf to 1080/23psf to 1080/59i (480/59i), or from 1080/25psf to 1080/24psf to 1080/60i

Input the pre-conversion 25-frame count TC (25TC) value that will serve as the reference during conversion and the post-conversion 24/30-frame count TC (24TC)/(30TC) value. SYNC PHASE is valid during the 24TC to 30TC conversion.

Audio insert editing function with 23.98 Hz VTR system and 30 Hz external operating environments

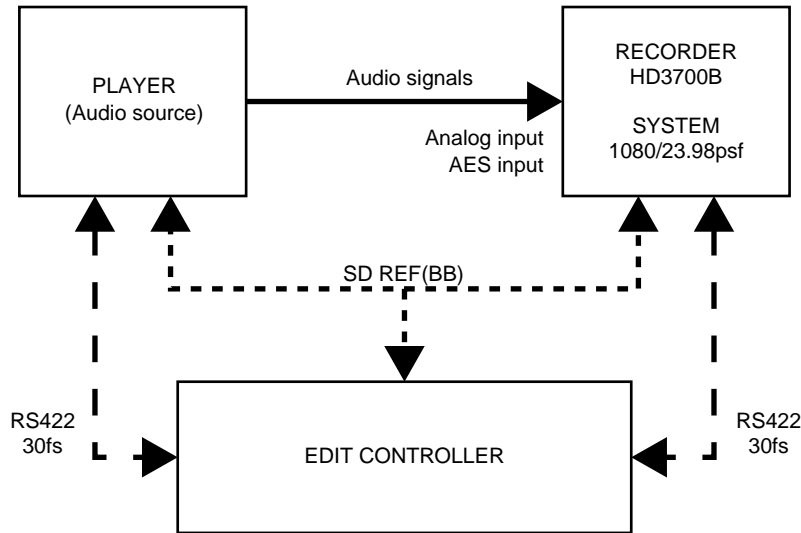

As shown in the above diagram of the system connections, this function enables audio insert editing on the 23.98P tape of the model HD3700B even in an environment with a 30 Hz external device, and by so doing, the efficiency of the editing work is improved. Refer to the information provided later for details on the VTR menu settings.

<Editing accuracy>

With the model HD3700B, the IN/OUT point accuracy falls into one of the following three patterns since the signals are recorded with the video and input audio phases aligned (there is no misalignment between the audio and video phases) on the tape. (Bear in mind that, as shown in patterns 2 and 3, the IN and/or OUT points may shift.)

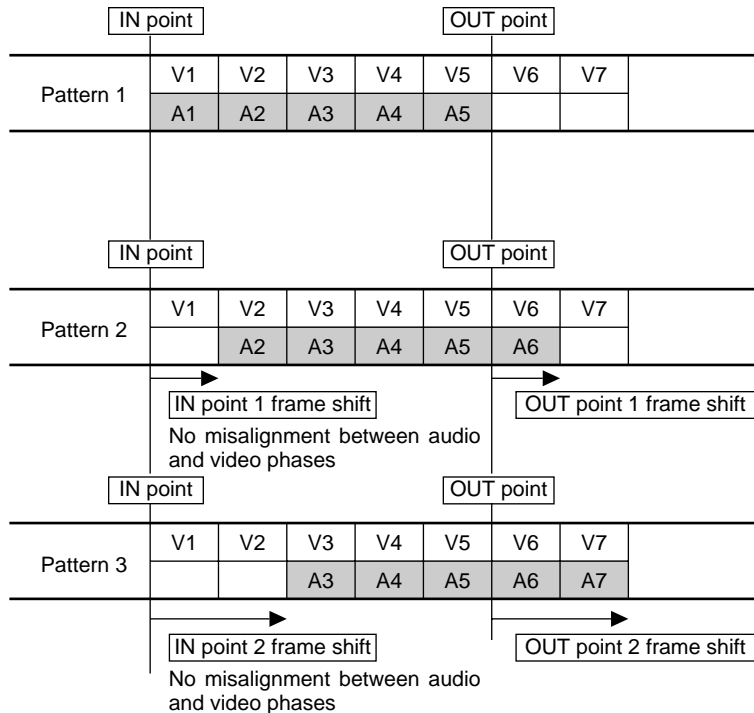

Audio insert editing function with 23.98 Hz VTR system and 30 Hz external operating environments

<Points to note>

The function will not work unless the following conditions are met.

- (a) The system frequency of the VTR must be set to 23.98 Hz.
- (b) The black burst reference signal must be connected.
- (c) The settings below must be selected for the following items on the TC/CHR CONVERT menu:
RC_30SYS (F6) ON
RC_TC (F10) 30TC
- (d) Use the AES input or analog input as the audio input signals, and make sure that embedded audio signals are not selected.
(Otherwise, the signals may be edited with the audio and video phases misaligned.)
- (e) The settings below must be selected for the following item on the INTERFACE SETUP menu:
VAR LIMT (F10) OFF

This function can be executed for audio insert editing only. Bear in mind that, in the status where the settings above have been completed, the following editing modes are prohibited and cannot be set.

- Assemble editing mode
- Insert (video) editing mode
- Insert (CUE selection) editing mode
- Insert (TC selection) editing mode

Bear in mind that if, after the edit channel selection has been entered, one of the applicable prohibition conditions has been established from an external source (9-pin or 232C connector) or by loading a user file or by other means, the EDIT preset command or insert operation (video, CUE or TC) will be masked and executed.

LTC output selection when playing back a 25P (23.98P/24P) tape with a 23.98/24 (25) Hz VTR system added

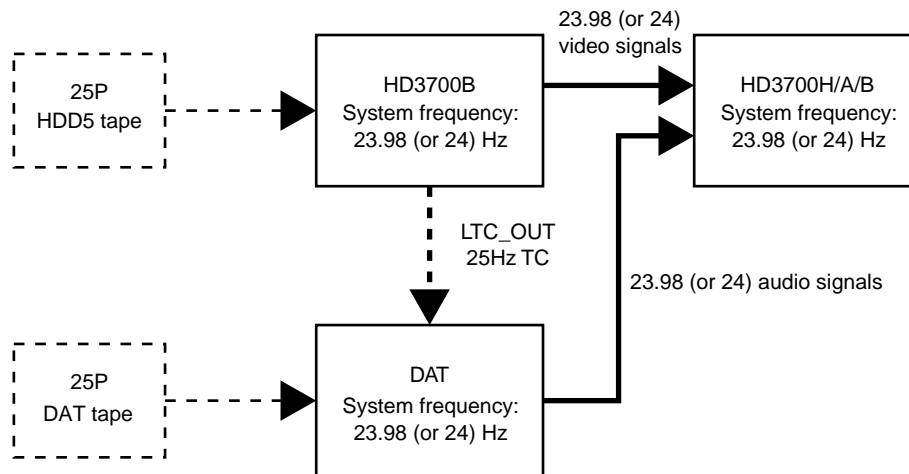

Since, as shown in the figure above, the video and audio signals are synchronized in the system in which a tape recorded with a system frequency of 25 Hz is played back on a VTR with a system frequency of 23.98 (or 24) Hz, this function enables 25 Hz TC information to be supplied to an external DAT device for synchronized operation with the VTR.

When a 1080/25P recorded tape is to be played back in this way on a VTR with a system frequency of 23.98 (or 24) Hz, the function makes it possible for the operator to select that the original 25-frame count TC recorded on the tape be output from the LTC_OUT connector in addition to the 24-frame count TC.

Conversely, when a 1080/23.98P or 1080/24P recorded tape is to be played back on a VTR with a system frequency of 25 Hz, the function enables not only the 25-frame count TC but also the original 24-frame count TC recorded on the tape to be output from the LTC_OUT connector.

[Bear in mind that, with the model AJ-HD3700H, audio signals will not be output properly when a 23.98P (or 24P) tape is played back on a VTR with a system frequency of 25 Hz.]

In short, the function expands the ability of systems to support the connection with and operation of external devices, and it does this by making it possible for the original TC of pre-recorded tapes to be selected and output from the LTC_OUT connector even when the system frequency of the VTR is at variance from the frequency of the pre-recorded tapes in the manner explained above.

Refer to page 87 for the VTR menu setting items.

(Furthermore, the LTC waveforms which are output from the LTC_OUT connector using this function differ from the waveforms defined in the specifications. This is because the tapes are played back at a different speed from the speed at which they were recorded even when they are played back at the normal tape speed.)

MULTI CUE menu

This menu is displayed by pressing the following key: MULTI CUE

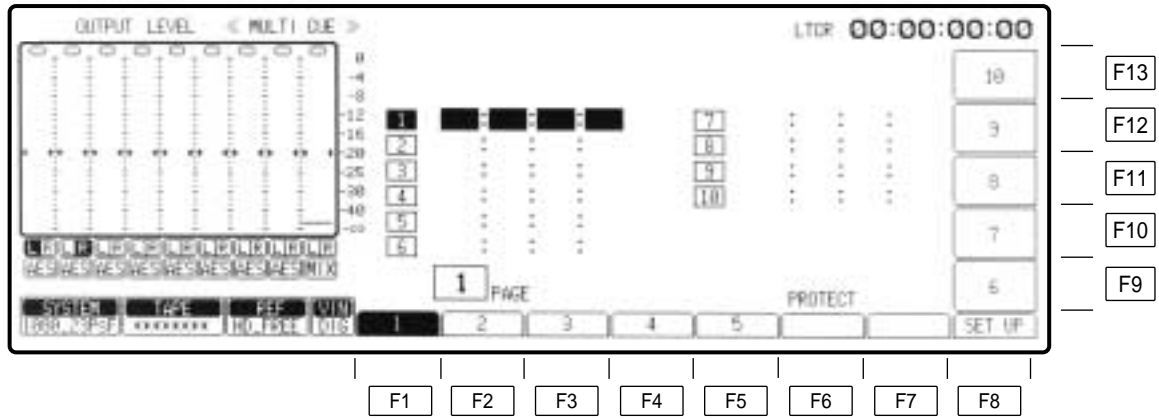

MULTI CUE menu

| Key | Key designation | Description |
|-----|--|---|
| F1 | 1 For designating the cue number 1 and page. | |
| F2 | 2 For designating the cue number 2 and page. | |
| F3 | 3 For designating the cue number 3 and page. | Designates the cue number for registering the cue point. When the key is pressed together with the F key, the page for registering the point is also designated. |
| F4 | 4 For designating the cue number 4 and page. | |
| F5 | 5 For designating the cue number 5 and page. | |
| F6 | PROTECT For designating protection on a page by page basis. | This function is executed by pressing this key together with the F key. ON: Sets the displayed page to the protected status. Cue points on this page cannot be registered, changed or cleared. OFF: Releases the protected status of the page displayed. Cue points on this page can be registered, changed or cleared. |
| F7 | — | |
| F8 | SET UP | Transfers to the MULTI CUE SET UP menu screen. |
| F9 | 6 For designating the cue number 6 and page. | |
| F10 | 7 For designating the cue number 7 and page. | |
| F11 | 8 For designating the cue number 8 and page. | Designates the cue number for registering the cue point. When the key is pressed together with the F key, the page for registering the point is also designated. |
| F12 | 9 For designating the cue number 9 and page. | |
| F13 | 10 For designating the cue number 10 and page. | |

MULTI CUE menu

□ Switching the pages

- A particular page can be selected by pressing one of the F1 (1) through F5 (5) or F9 (6) through F13 (10) keys together with the F key.
 - The pages are scrolled up when the F key and “▶” key are pressed together.
 - The pages are scrolled down when the F key and “◀” key are pressed together.
- If an attempt is made to scroll down from page 1, page 10 will be displayed.
If an attempt is made to scroll up from page 10, page 1 will be displayed.



□ Protecting pages

When the F6 (PROTECT) key and F key are pressed together, the protected status is set for the page displayed.
When the F6 key and F key are pressed together again, the protected status is released.
Once protected, the number of the page is displayed as follows:

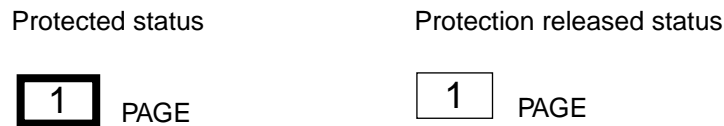

□ Entering cues

Up to a hundred cue points can be entered.

- (1) Select the number of the cue point to be entered.
Press one of the F1 through F5 or F9 through F13 keys. The number corresponding to the pressed key appears in reverse video.
- (2) Input the time code.
There are three ways of inputting the time code.
 - 1) Use the search dial to search the cue point, and press the ENTRY button.
 - 2) Input the time code directly using the number keys, and press the ENT key.
 - 3) Move the cursor to the section where the value can be captured.
 1. Press the FROM key.
The time code of the cursor position is captured in the scratchpad register.

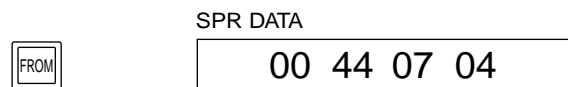

2. Increment or decrement the number using the “+,” “-” and number keys.



3. Press the ENT key.
The result of the operation is now displayed.

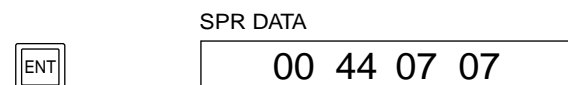

MULTI CUE menu

4. Move the cursor to the section where the captured time code is to be displayed.

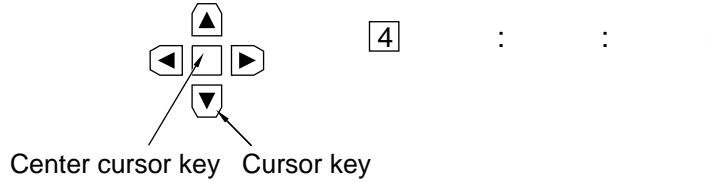

5. Press the COPY key to call the captured time code.



- The position of the next cue number automatically appears in reverse video when the F1 (AUTO STEP) key on the MULTI CUE SET UP menu has been set to ON.
- An entered cue point remains in the memory even when the power is turned off.

□ Changing cue points

Proceed as follows to change an already entered cue point.

- (1) Press the key (F1–F5, F9–F13) corresponding to the cue to be entered.
- (2) Press the cursor keys to move the column cursor to the time code of the cue point to be changed.

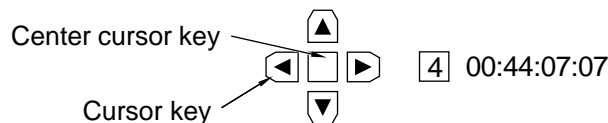

- (3) Press the center cursor key to change the cursor to the column cursor, and then input the value using the number keys.



- (4) Press the ENT key.

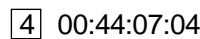

□ Clearing cue data

Proceed as follows to clear an already entered cue point.

- (1) Press the key (F1–F5, F9–F13) corresponding to the cue to be cleared.
- (2) Press the C key.
- (3) Press the ENT key.

□ Clearing all the cue points

Press the F8 (SET UP) key, and then press the F3 (PAG CLR) on the SET UP menu and F key together. All the cue points on the page concerned are now cleared. To clear all the cue points on all the pages (with the exception of the cue points on protected pages), press the F5 (ALL CLR) and F key together.

MULTI CUE SET UP menu

This menu is displayed by pressing the following keys: **MULTI CUE** → **F8**

The screenshot shows the 'MULTI CUE SET UP' menu with the following elements:

- OUTPUT LEVEL:** A vertical scale from 0 to -50 with eight sliders.
- LTOR:** A digital display showing '00:00:00:00'.
- RIGHT SIDE MENU:**
 - CUE ROLL:** 5 SEC (F13)
 - AUTO FRZ:** OFF (F12)
 - MAX SP:** -1***2 (F11)
 - CLUTCH:** OFF (F10)
 - EXIT:** (F9)
- MIDDLE RIGHT:** A 'STILL' indicator with a vertical bar and arrows.
- TOP ROW:** A row of eight buttons labeled F1 through F8.
- BOTTOM ROW:** A row of buttons for 'AUTO STEPPAG MODE', 'PAG CLR', and 'ALL CLR', with 'OFF' indicators.

MULTI CUE SET UP menu

| Key | Key designation | Description |
|-------|---|--|
| F1 | AUTO STEP For setting the auto step mode. | <p>ON: Moves the cursor to the next item automatically when a cue point is registered.</p> <p>OFF: Cursor is not moved.</p> <ul style="list-style-type: none"> •When F2 (PAG MODE) below is at ON, the cursor moves only on the page. For example, upon completion of registration of cue point number 10, the cursor moves to the time code input site of cue number 1 on the same page. •When F2 (PAG MODE) below is at OFF, the cursor moves between two pages. For example, upon completion of registration of cue point number 10, the cursor moves to the time code input site of cue number 1 on the next page. |
| F2 | PAG MODE For setting the cursor movement mode. | <p>ON: Cursor moves only on the same page.</p> <p>OFF: Cursor moves between two pages.</p> |
| F3 | PAG CLR For clearing cue data on a page. | <p>All the cue data on a page is cleared. This function is executed when the key is pressed together with the F key.</p> <ul style="list-style-type: none"> •Data on a protected page is not cleared. |
| F4 | — | |
| F5 | ALL CLR For clearing all the cue data. | <p>All the cue data is cleared. This function is executed when the key is pressed together with the F key.</p> <ul style="list-style-type: none"> •Data on a protected page is not cleared. |
| F6–F7 | — | |
| F8 | EXIT | Returns the VTR to the MULTI CUE menu screen. |
| F9 | CLUTCH For setting the dial clutch in the VAR mode. | <p>ON: Sets the clutch to the –1a, 0a, +1a or +2a speed.</p> <p>OFF: The clutch is not set.</p> |
| F10 | MAX SP. For setting the maximum tape speed in the VAR mode. | <p>–1 ← → +2: Tape speed in the range of –1 to +2</p> <p>–1 ← → +1: Tape speed in the range of –1 to +1</p> <p>0 ← → +1: Tape speed in the range of 0 to +1</p> |
| F11 | AUTO FRZ* For setting the freeze frame output in the VAR mode. | <p>ON: A freeze frame is output when the EXECUTE button is pressed during variable mode. (Tape running continues.) The setting is released when the STOP, PLAY, FF, REW, JOG, VAR or SHTL button is pressed.</p> <p>OFF: A freeze frame is not output.</p> |
| F12 | — | |
| F13 | CUE ROLL For setting the preroll time. | <p>Sets the preroll time. Preroll time can be set in 1-second steps from 0 to 30 sec.</p> |

*This item is operational on the MULTI CUE menu screen.

INSERT/ASSEMBLE MANUAL EDIT menu

Press the [ASSEM] (or [INSERT]) → [F12] keys to display the MANUAL EDIT menu.

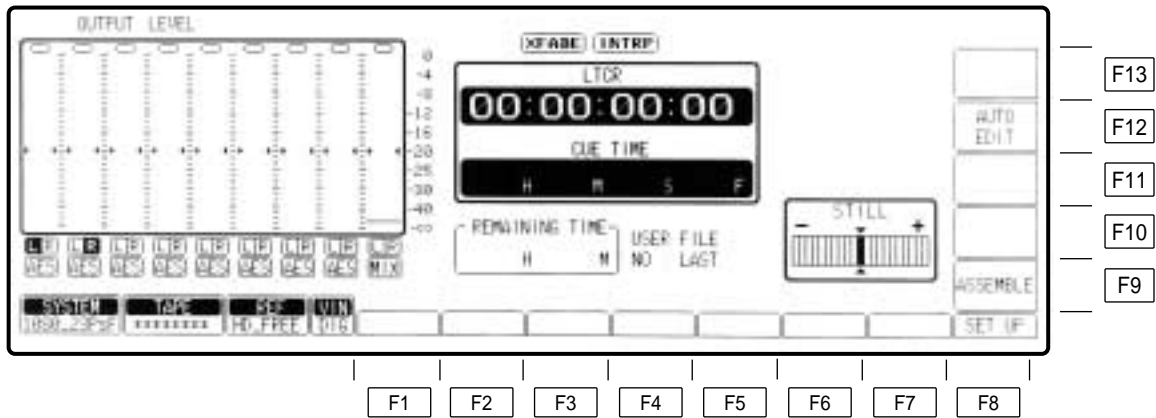

| Key | Key designation | Description |
|---------|---|--|
| F1–F7 | — | |
| F8 | SET UP | Transfers the VTR to the MANUAL EDIT SET UP menu screen. |
| F9 | INSERT/ASSEMBLE For setting the editing mode ON/OFF. | Selects the editing mode. ON: Sets the editing mode to ON. OFF: Sets the editing mode to OFF. |
| F10–F11 | — | |
| F12 | AUTO EDIT | Transfers the VTR to the AUTO EDIT menu screen. |
| F13 | CH SELECT For selecting the editing channel. | Transfers the VTR to the INSERT MANUAL EDIT CH SELECT (editing channel selection) menu screen (but only for insert editing). |

INSERT MANUAL EDIT CH SELECT menu

This menu is displayed by pressing the following keys: **INSERT** → **F12** → **F13**

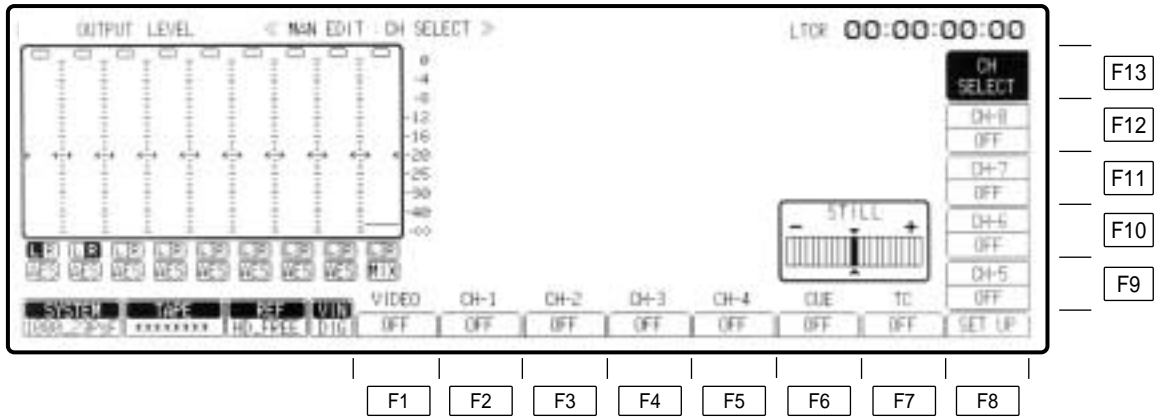

*CH-5 to CH-8 are not displayed when PCM audio has been set to the 4-channel format.

INSERT MANUAL EDIT CH SELECT menu

| Key | Key designation | Description |
|-----|---|---|
| F1 | VIDEO For selecting the video channel ON/OFF. | |
| F2 | CH-1 For selecting the audio CH1 ON/OFF. | For selecting the editing channel. Valid only for insert editing. |
| F3 | CH-2 For selecting the audio CH2 ON/OFF. | ON: Selected as the editing channel. OFF: Not selected as the editing channel. |
| F4 | CH-3 For selecting the audio CH3 ON/OFF. | ● In the case of insert editing with selection of digital audio channel only, be sure to continue with a stabilized input video signal. |
| F5 | CH-4 For selecting the audio CH4 ON/OFF. | If the input video signal is distorted, audio might not be recorded properly. |
| F6 | CUE For selecting the cue channel ON/OFF. | |
| F7 | TC For selecting the LTC time code channel ON/OFF. | |
| F8 | SET UP | Transfers the VTR to the MANUAL EDIT SET UP menu screen. |
| F9 | CH-5 For selecting the audio CH5 ON/OFF. | For selecting the editing channel. Valid only for insert editing. |
| F10 | CH-6 For selecting the audio CH6 ON/OFF. | ON: Selected as the editing channel. OFF: Not selected as the editing channel. |
| F11 | CH-7 For selecting the audio CH7 ON/OFF. | ● In the case of insert editing with selection of digital audio channel only, be sure to continue with a stabilized input video signal. |
| F12 | CH-8 For selecting the audio CH8 ON/OFF. | If the input video signal is distorted, audio might not be recorded properly. |
| F13 | CH SELECT | Transfers the VTR to the INSERT MANUAL EDIT menu screen. |

INSERT/ASSEMBLE MANUAL EDIT SET UP menu

Press the **ASSEM** (or **INSERT**) → **F12** keys to change to the MANUAL EDIT menu, then press the **F8** key to display this menu.

OR

Press the **SET UP** → **F2** keys to display this menu.

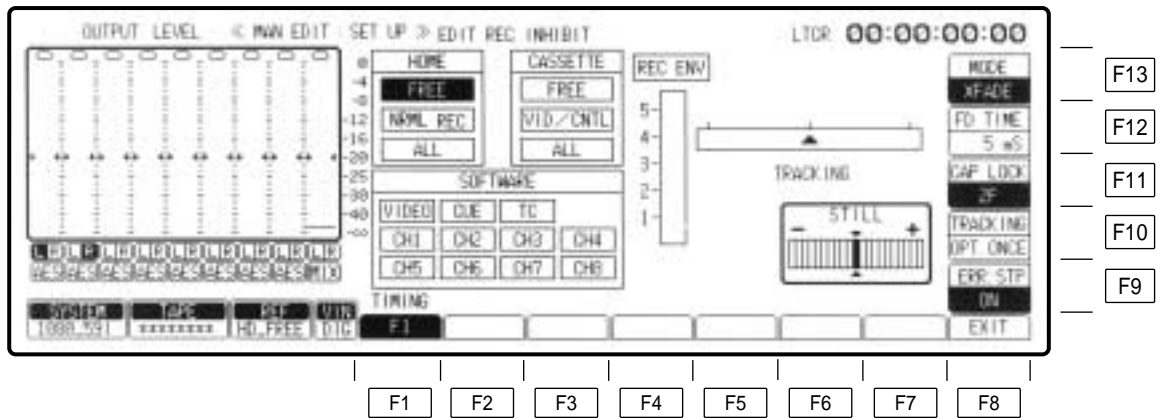

INSERT/ASSEMBLE MANUAL EDIT SET UP menu

| Key | Key designation | Description |
|-------|---|--|
| F1 | TIMING* For setting the edit timing. | <p>Sets the timing with which to record the fields at the edit IN point and OUT point. This menu item can be set by pressing the F1 key and the F key together.</p> <p>F1: Editing starts from the odd-numbered field at the IN point, and it ends when an even-numbered field one frame before the OUT point is recorded.</p> <p>F2: Editing starts from the even-numbered field at the IN point, and it ends when an odd-numbered field at the OUT point is recorded.</p> <p>F1/F2: The fields for the edit IN point and OUT point are determined by the timing at which the edit command is issued. If the edit timing command is issued in an even-numbered field, editing is ended in an odd-numbered field; conversely, if the edit timing command is issued in an odd-numbered field, editing is ended in an even-numbered field.</p> <ul style="list-style-type: none"> •The edit timing can also be set on the AUTO EDIT SET UP menu. If a different mode has been set on the AUTO EDIT SET UP menu, the mode which has been set on the INSERT/ASSEMBLE MANUAL EDIT SET UP menu will be changed. •The F1 setting is forcibly established when the CONTROL (REMOTE/LOCAL) switch has been set to LOCAL. |
| F2–F7 | — | |
| F8 | EXIT | Returns the VTR to the MANUAL EDIT menu screen. |
| F9 | ERR.STP Error stop. | <p>When the ENV value at which editing started (5 frames before) has dropped to 25% below the REC ENV value when optimizing was completed, an error is considered to have occurred, and one of the following operations is selected.</p> <p>ON: During execution of editing in optimize mode, if an error has occurred up to the IN point, editing is aborted and the stop mode is assumed.</p> <p>OFF: Displays a message and continues editing when an error has occurred.</p> |
| F10 | TRACKING For adjusting the tracking. | <p>Under normal times, tracking adjustment is not necessary. Adjustment is made if tracking disparities have occurred during editing.</p> <p>VAR: The tracking can be adjusted manually. Refer to “Manually adjusting the tracking” (on page 106).</p> <p>FIX: The tracking is fixed.</p> <p>OPT. ONCE: At the initial editing after the cassette has been inserted, the tracking is optimized while the tape is playing back up to the IN point. The tracking is not subsequently optimized. When the PLAY button and STAND BY button are pressed together during EDIT/PLAY, the tracking is optimized again, and it is optimized with each EDIT/PLAY operation.</p> <p>OPT. AUTO: The tracking is optimized while the tape is playing back up to the IN point with each editing operation, and it is retained even if the VTR is transferred to another menu. Refer to “Automatically adjusting the tracking.”</p> |

*This item cannot be displayed when the 1080/23p, 1080/24p, 1080/25p or 720/59p format has been selected. (It is forcibly set to F1.)

INSERT/ASSEMBLE MANUAL EDIT SET UP menu

| Key | Key designation | Description |
|-----|---|---|
| F11 | CAP LOCK For setting the capstan servo lock. | For selecting the capstan servo lock mode during playback. 4F AUTO (8F AUTO: 1080/23p, 1080/24p, 1080/25p, 1080/50i, 576/50i): Assumes the color frame auto lock mode. If discontinuity is produced in the color frame during playback, the unit locks again to a new color frame. 4F FORCE (8F FORCE: 1080/23p, 1080/24p, 1080/25p, 1080/50i, 576/50i): Assumes the color frame forced lock mode. If there is any discontinuity in the color frame during playback, the unit preserves the field sequence at initial lock. 2F: Assumes frame lock mode. ●The capstan servo lock mode can be set in HOME SET UP menu. If the two settings differ, priority is given to the final mode setting. |
| F12 | FD TIME* For setting the audio fade time. | Valid when the F13 key is set to X FADE or V FADE. The times that can be set are as follows: 5, 10, 15, 20, 25, 50, 100 ms. (Initial setting is 5 ms.) For the setting procedure, refer to "Selecting the audio fade time" (on page 107). |
| F13 | MODE* For setting the audio fade edit. | Audio editing can be accomplished while cross-fade editing prior playback audio and input audio or V-fade editing. X FADE: Performs audio cross-fade editing. CUT: Performs cut (normal) editing. V FADE: Performs audio V-fade editing. |

*Only CUT can be selected when TAPE has been selected as the EDIT REC STATE setting. However, FADE can be selected by pressing this key and F key together, in which case the EDIT REC STATE setting is switched to EE1.

INSERT/ASSEMBLE MANUAL EDIT SET UP menu

EDIT REC INHIBIT mode display

This display shows the statuses of the editing inhibit modes.



●SOFTWARE

The editing inhibit modes selected for each channel are shown here. Refer to "Selecting the SOFTWARE inhibit channels."

VIDEO: Video channel editing is inhibited.

CH1-CH8

(CH4): Digital audio channel editing is inhibited.

CUE: Cue channel editing is inhibited.

TC: Time code channel editing is inhibited.

●HOME

The recording inhibit modes established using the F13 (REC INH) key on the HOME menu are shown here.

FREE: Recording can be performed.

NRML REC: The normal recording mode is inhibited.

ALL: All recording/editing operations are inhibited.

●CASSETTE

The recording inhibit modes established by the cassette tape are shown here.

FREE: Recording can be performed.

VID/CNTL: The video and control signals are inhibited.

ALL: All recording/editing operations are inhibited.

Sequence of priority for recording inhibit modes

A sequence of priority applies to the inhibit modes and, depending on which modes have been selected, it may not be possible to perform recording. If, for example, "ALL" has been selected for CASSETTE, no editing or recording will be possible regardless of the other settings.

| | |
|---------|----------|
| First: | CASSETTE |
| Second: | HOME |
| Third: | SOFTWARE |

INSERT/ASSEMBLE MANUAL EDIT SET UP menu

□ Selecting the SOFTWARE inhibit channels

(1) Press the center cursor key. The cursor now appears.

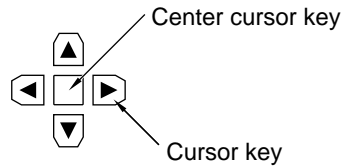

(2) Press the cursor key to move the cursor to the channel where editing is to be inhibited.

CH4

(3) Press the center cursor key. Once the display appears in reverse video, the selection of the editing inhibit channel is completed. When the center cursor key is pressed again, the editing inhibit is released.

CH4

- Assembly editing cannot be selected if there is even one editing inhibit channel.

<Notes>

- When ALL or PRE CTL has been set for CASSETTE EDIT REC INHIBIT or HOME REC INHIBIT, all recording and editing operations will be inhibited.
- When VIDEO/CNTL has been set for CASSETTE EDIT REC INHIBIT, editing inhibit applies to the video channel at all times.

□ REC ENV display

This shows the RF envelope level at which sound is played back from the rotary recording heads during playback.

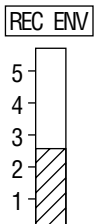

INSERT/ASSEMBLE MANUAL EDIT SET UP menu

□ Tracking

● Automatically adjusting the tracking (optimizing)

To optimize the tracking automatically, press the F10 (TRACKING) key to select OPT ONCE or OPT AUTO.

Set the preroll time to 5 seconds or more.

- At the OPT ONCE setting, the tracking is optimized only once while the tape is playing up to the IN point during the first editing after the cassette has been inserted. The tracking is not subsequently optimized, and the value is fixed.
- At the OPT AUTO setting, the tracking is optimized while the tape is playing up to the IN point with each editing.

<Notes>

- The OPT ONCE setting is suitable when continuous editing is to be performed such as in the case below. (If OPT AUTO is set when this kind of editing is to be performed, the tracking error may build up.)

| | | | | |
|------|--------|--------|--------|------|
| Base | Edit ① | Edit ② | Edit ③ | Base |
|------|--------|--------|--------|------|

- The OPT AUTO setting is suitable when intermittent editing is to be performed such as in the case below.

| | | | | |
|------|--------|------|--------|------|
| Base | Edit ① | Base | Edit ② | Base |
|------|--------|------|--------|------|

- Proceed as follows to optimize the tracking again using OPT ONCE.

- (1) Press the INSERT or ASSEMBLE button to highlight the F9 key and establish the editing mode. Check that the INSERT or ASSEMBLE LED has lighted.

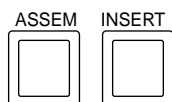

- (2) Press the PLAY button to establish the PLAY (EDIT PLAY) mode.

- (3) Optimizing is initiated by pressing the PLAY and STAND BY buttons together.

<Notes>

- (1) The optimized tracking value is retained even when the VTR is transferred to another menu.
- (2) The following message appears while the tracking is being optimized, and the ▲ mark that indicates the tracking value appears to show the progress made in the processing.

OPTIMIZING

Upon completion of the optimizing, the following message appears, the TRACK OPT appears on the INSERT/ASSEMBLE MANUAL EDIT and HOME menu screens.

COMPLETE

INSERT/ASSEMBLE MANUAL EDIT SET UP menu

- (3) The following message appears and optimizing is suspended in the following cases:
- When the VTR is set to a mode other than PLAY while optimizing is underway.
 - When optimizing has failed.
 - When no video signals have been recorded on the tape.
 - When no CTL signals have been recorded on the tape.

NOT COMPLETE

At times like these, the center value (0) is set as the optimized value.

- (4) If the optimizing processing fails to be completed even after 5 seconds, the following message appears and optimizing is suspended.

TIME OVER

- (5) When the cassette is ejected, the optimized value is canceled.

□ Manually adjusting the tracking

- (1) Insert the tape, and play it back.
- (2) Press the F10 (TRACKING) key and set it to VAR.

TRACKING
VAR

- (3) Turn the ADJUST control, and adjust it so that the envelope level is set to its maximum.

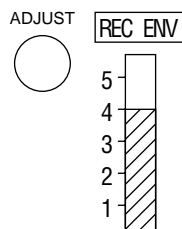

INSERT/ASSEMBLE MANUAL EDIT SET UP menu

□ Selecting the audio fade time

- (1) Press the F13 (MODE) key to set it to X FADE or V FADE.

MODE
X FADE

- (2) Press the F12 (FD TIME) key.

FD TIME
10

- (3) Turn the ADJUST control to select the audio fade time.

ADJUST
25



The solid lines indicate X fading.
The broken lines indicate V fading.

<Note>

The V fade time is a multiple of the time set for FD TIME.
If, for instance, FD TIME is to be set to 100ms:

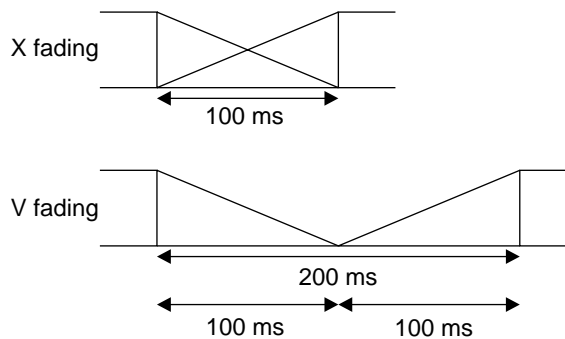

INSERT/ASSEMBLE AUTO EDIT menu

The AUTO EDIT menu is displayed by pressing the following keys: **ASSEM** or **INSERT** → **F12**

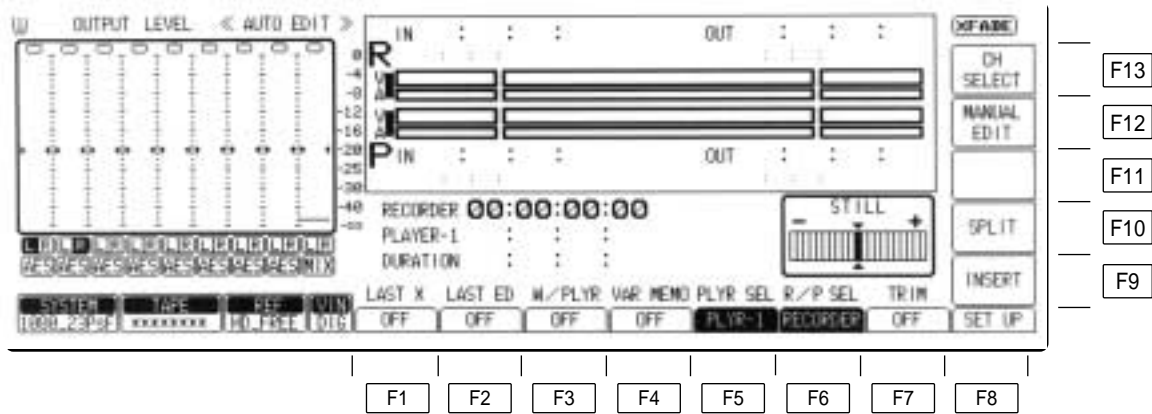

INSERT/ASSEMBLE AUTO EDIT menu

| Key | Key designation | Description |
|-----|--|---|
| F1 | LAST X For calling the edit data to be input. | When the F1 key is pressed, "LOAD" is displayed, and the edit data which was input last is called. |
| F2 | LAST ED For calling all the last data edited. | When the F2 key is pressed, "LOAD" is displayed, and all the data which was edited last is called. |
| F3 | W/PLYR Continuous VTR remote control ON/OFF. | Performs remote control of VTR connected by RS-422A. ON: Remote control possible. OFF: Unit operated independently. ●See also F5 (PLYR SEL) key. |
| F4 | VAR MEMO Variable memory. | This function stores the playback speed and direction settings established by the search dial in its memory and automatically reproduces these settings. (At times, these settings are reproduced by one's own VTR; at other times, they may control the player that is connected.) ON: Enables the variable memory function. OFF: Disables the variable memory function. |
| F5 | PLYR SEL Selects player for remote control. | PLYR-1: Controls the VTR connected to REMOTE OUT connector. PLYR-2: Controls the VTR connected to REMOTE IN/OUT connector. |
| F6 | R/P SEL Selects VTR for operation. | PLAYER: Performs remote control of the player selected by F5 (PLYR SEL) key. RECORDER: Control is the main unit (recorder) only. |
| F7 | TRIM Frame correction of edit point. | ON: Registered edit points are corrected by frame unit. OFF: Releases trim function. |
| F8 | SET UP | Transfers the VTR to the AUTO EDIT SET UP menu screen. |
| F9 | INSERT For setting the editing mode ON/OFF. | ON: Sets the editing mode ON. OFF: Sets the editing mode OFF. |
| F10 | SPLIT Split editing ON/OFF. | This function registers each audio and video edit point during insert editing. ON: Enables split editing. OFF: Releases split editing. (For details, refer to pages 41 and 42 in the Hardware Operating Instructions.) |
| F11 | — | |
| F12 | MANUAL EDIT | Transfers the VTR to the MANUAL EDIT menu screen. |
| F13 | CH SELECT Edit channel selection. | Transfers the VTR to the INSERT AUTO EDIT CH SELECT (editing channel selection) menu screen (but only for insert editing). |

INSERT/ASSEMBLE AUTO EDIT menu

□ Tape position indicator

This indicates the edit points (IN and OUT) and tape positions of the recorder and player.

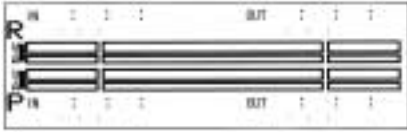

- EOT (end of tape) or BOT (beginning of tape) is displayed when the tape is at its end or beginning.
- During split editing, the audio and video edit points are indicated separately.

□ Duration

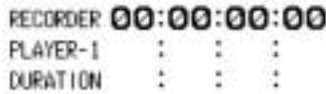

If the duration is known, it is sufficient to enter only the IN or OUT edit points for the recorder and player: the remaining points will be automatically calculated.

- (Recorder's time code readout value)
- (Player's time code readout value)
- (Editing time)

□ Entering the edit points

(1) Input the points directly using the number keys.

- 1) Press the center cursor key.
The cursor now appears.

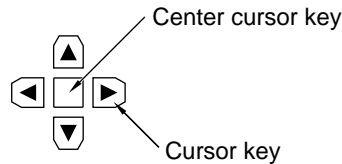

- 2) Press the cursor key to move the cursor to the data input position (player's IN point in the figure).

IN : : :

P

- 3) Press the center cursor key.
The cursor now changes into a column cursor.

IN 0 : : :

P

- 4) Input the edit point using the number keys.



- 5) Press the ENT key.
Follow the same steps to enter the IN and OUT points of the recorder and player.

- Enter three edit points for the recorder and player.
(Refer to the section on duration.)
- **To clear the data:** Move the cursor to the position where the data is to be cleared, and press the center cursor key. The cursor now changes into a column cursor. The entered point can be cleared by pressing the C key now.

INSERT/ASSEMBLE AUTO EDIT menu

(2) Search the edit point using the search dial.

- 1) Search the edit point using the search dial.
- 2) Press the ENTRY button.

•Trimming operations

- (1) Press the center cursor key.
The cursor now appears.

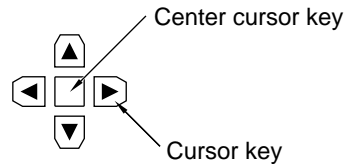

- (2) Press the cursor key to move the cursor to the section with the data to be trimmed.

IN 00:00:02:14

R

- (3) Set the F7 (TRIM) key to ON.

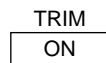

- (4) Press the center cursor key again so that the cursor is made to serve as a column cursor.

- (5) Press the “+” or “-” button to trim the edit point in 1-frame increments.

Each time the “+” button is pressed, the point is incremented by 1 frame.

If the “+” button is held down, the point is incremented continuously.

- (6) Press the F7 (TRIM) key to set it to OFF.

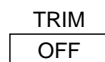

IN 00:00:02:16

R

<Notes>

When the edit points are entered during editing with the player or editor (recorder), the final (fourth) edit point is automatically calculated from the other edit points and entered as a virtual edit point.

- The “*” mark appears at the side of a virtual edit point display.
- If a virtual edit point is to be cleared, it will be cleared automatically by clearing the other edit points.

INSERT/ASSEMBLE AUTO EDIT menu

Input the data using the scratchpad.

- 1) Press the center cursor key.
The cursor now appears.

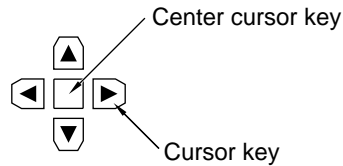

- 2) Press the cursor key to move the cursor to the time code IN or OUT position which is to be input.
- 3) Press the FROM key.
The time code at the cursor position is displayed inside the register.

SPR DATA

00 : 14 : 03 : 05

- 4) Use the "+", "-" and number keys to increment or decrement the time code, and press the ENT key.
The operation result is now displayed inside the register.
- 5) Press the cursor keys to move the cursor to the cursor position (IN or OUT) to which the operation result is to be copied.
- 6) Press the COPY key.
The time code of the changed edit point is now displayed.

- If an illegal number was input during the incrementing or decrementing in step 4), an error message will appear.

ERROR INVALID TC DATA

- Corrections can be made until the COPY key is pressed.

• Calling the edit data which was input last

- (1) Press the center cursor key.
The cursor now appears.
- (2) Press the cursor key to move the cursor to the data section which is to be called.
- (3) Press the F1 (LAST X) key to set it to LOAD.
The data which was input last now appears.

IN 00:00:02:16

• Calling all the data which was edited last

- (1) Press the F2 (LAST ED) key to set it to LOAD.
All the data which was edited last now appears.

INSERT/ASSEMBLE AUTO EDIT menu

□ Variable memory function

1. Set the F3 (W/PLYR) key to OFF.

W/PLYR
OFF

2. Set the F4 (VAR MEMO) key to ON.

VAR MEMO
ON

- If the IN and OUT points have already been entered, they are automatically cleared.
 - If ON is set for the split mode, it is forcibly set to OFF.
 - When the variable memory function is used, AUDIO IN and OUT points cannot be entered.
3. Input the VTR's edit IN point.
This serves as the variable memory playback start point.
 - There is no need to set the OUT point with variable memory playback.
 4. Set the initial speed using the search dial.
The initial speed is now shown on the search indicator.
 5. Press the PREROLL and EXECUT buttons together to start operation.
The tape travels to the preroll point, and playback starts at the initial speed.
 6. When the edit IN point is passed, the EXECUTE button lamp starts blinking.
 7. Turn the search dial and enter the tape speed in the memory.
 - The data can be stored in the memory while the EXECUTE button lamp is blinking.
When the memory becomes full, the EXECUTE button lamp comes on, and no more data can be stored in the memory.
 - To change the initial speed or data stored in the memory, repeat the procedure from step 4.
 8. To end the variable memory operation, press the STOP button.
 9. To reproduce the data stored in the memory, press the EXECUTE button.
- The tape plays from the position past the IN point in accordance with the data stored in the memory, and it keeps traveling at the last speed stored in the memory until the STOP button is pressed.
 - The data stored in the memory is cleared when the F4 (VAR MEMO) button is set from OFF to ON.
It is also cleared when the power switch is set to OFF.

INSERT/ASSEMBLE AUTO EDIT menu

□ Variable memory editing

By operating the search dial on a VTR connected to the unit's RS-422A REMOTE OUT connector or REMOTE IN/OUT connector, the playback speed and direction can be stored in that VTR's memory, and the memory data can be reproduced during automatic editing and stored in this unit (recorder).

1. Set the F3 (W/PLYR) key to ON.

W/PLYR
ON

- To operate the VTR connected to the REMOTE OUT connector by remote control, set F5 (PLYR SEL) on the ASSEMBLE/INSERT AUTO EDIT menu to PLAY-1.
- To operate the VTR connected to the REMOTE IN/OUT connector by remote control, set F5 (PLYR SEL) on the ASSEMBLE/INSERT AUTO EDIT menu to PLAY-2.

2. Set the F4 (VAR MEMO) key to ON.

VAR MEMO
ON

3. Enter the recorder's video IN and OUT points as well as the player's IN point.
4. Select the player using the F6 (R/P SEL) key, and set the initial speed using the search dial. The initial speed is now shown on the search indicator.
5. Press the PREVIEW/REVIEW button.
The tape travels to the preroll point, and playback starts at the initial speed.
6. When the edit IN point is passed, the EXECUTE button lamp starts blinking.
7. Use the recorder's search dial to store the speed up to the recorder's OUT point in the memory.
The data can be stored in the memory up to the recorder's OUT point while the EXECUTE button lamp is blinking. When the memory becomes full, the EXECUTE button lamp comes on, and no more data can be stored in the memory.
8. To preview data stored in the memory, press the PREVIEW/REVIEW button.
The data stored in the memory is then reproduced.
Phase synchronization is not performed. To adjust the edit timing, use the F9 (DLY STRT) key on the INSERT/ASSEMBLE AUTO EDIT SET UP menu.
9. To change the data stored in the memory during preview, operate the search dial. The EXECUTE button lamp blinks, and the new data is stored.
10. Press the STOP button to change the initial speed which was stored in the memory.
Set the F6 (R/P SEL) key to PLAYER, and set the initial speed using the search dial while pressing the STOP button. If the initial speed is changed, the data stored in the memory will be cleared so repeat the operation from step 5.
11. To proceed with variable memory automatic editing, press the REC/EDIT button. The player's tape is played back in accordance with the data stored in the memory and entered in this unit (recorder).
12. To review, press the REC/EDIT button and, upon completion of the editing, press the PREVIEW/REVIEW button.
 - The data stored in the memory is cleared when the F10 (VAR MEMO) key is set from OFF to ON.
 - The data stored in the memory is also cleared when the power switch is set to OFF.

INSERT AUTO EDIT CH SELECT menu

This menu is displayed by pressing the following keys: **INSERT** → **F12** → **F13**

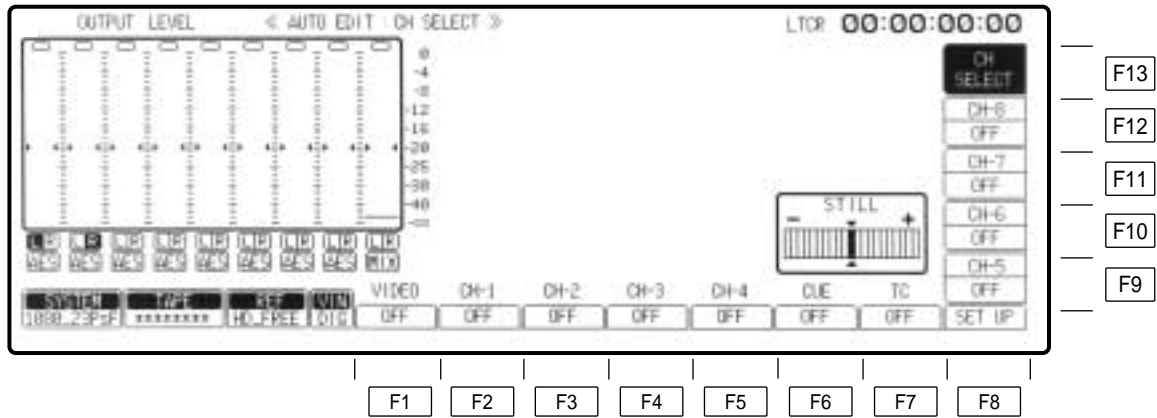

INSERT AUTO EDIT CH SELECT menu

| Key | Key designation | Description |
|-----|---|--|
| F1 | VIDEO For selecting the video channel ON/OFF. | |
| F2 | CH-1 For selecting the audio CH1 ON/OFF. | For selecting the editing channel. Valid only for insert editing. |
| F3 | CH-2 For selecting the audio CH2 ON/OFF. | ON: Selected as the editing channel. OFF: Not selected as the editing channel. |
| F4 | CH-3 For selecting the audio CH3 ON/OFF. | <ul style="list-style-type: none"> ● In the case of insert editing with selection of digital audio channel only, be sure to continue with a stabilized input video signal. If the input video signal is distorted, audio might not be recorded properly. |
| F5 | CH-4 For selecting the audio CH4 ON/OFF. | |
| F6 | CUE For selecting the cue channel ON/OFF. | |
| F7 | TC For selecting the LTC time code channel ON/OFF. | |
| F8 | SET UP | Transfers the VTR to the AUTO EDIT SET UP menu screen. |
| F9 | CH-5 For selecting the audio CH5 ON/OFF. | For selecting the editing channel. Valid only for insert editing. |
| F10 | CH-6 For selecting the audio CH6 ON/OFF. | ON: Selected as the editing channel. OFF: Not selected as the editing channel. |
| F11 | CH-7 For selecting the audio CH7 ON/OFF. | <ul style="list-style-type: none"> ● In the case of insert editing with selection of digital audio channel only, be sure to continue with a stabilized input video signal. If the input video signal is distorted, audio might not be recorded properly. |
| F12 | CH-8 For selecting the audio CH8 ON/OFF. | |
| F13 | CH SELECT | Transfers the VTR to the INSERT AUTO EDIT menu screen. |

INSERT/ASSEMBLE AUTO EDIT SET UP menu

This menu is displayed by pressing the following keys: **ASSEM** (or **INSERT**) to change to the AUTO EDIT menu, then press the **F8** key
 OR
SET UP → **F2**

The screenshot shows the 'INSERT/ASSEMBLE AUTO EDIT SET UP' menu. The menu is divided into several sections:

- OUTPUT LEVEL:** A vertical scale from 0 to -40 dB with a bar graph.
- HOME:** Buttons for FREE, MAN. REC, and ALL.
- CASSETTE:** Buttons for FREE, VID./CNTL, and ALL.
- SOFTWARE:** Buttons for VIDEO, CUE, TC, CH1-CH8.
- TRACKING:** A horizontal scale with a 'STILL' indicator.
- MODE:** Buttons for XFADE, FD TIME (5 mS), CAP LOCK, TRACKING, OPT. ONCE, DLY. STRT, and BFR.
- EXIT:** A button at the bottom right.
- Timing and Settings:** A row of buttons for TIMING, V. PREV, A. PREV, PLR. SYNC, PREROLL (5 SEC), POSTROLL (2 SEC), REACTION (8 FR), and EXIT.

Function key callouts are as follows:

- F13:** Points to the MODE menu.
- F12:** Points to the FD TIME menu.
- F11:** Points to the CAP LOCK menu.
- F10:** Points to the TRACKING menu.
- F9:** Points to the BFR menu.
- F1:** Points to the HOME menu.
- F2:** Points to the CASSETTE menu.
- F3:** Points to the SOFTWARE menu.
- F4:** Points to the TRACKING menu.
- F5:** Points to the TIMING menu.
- F6:** Points to the PREROLL menu.
- F7:** Points to the POSTROLL menu.
- F8:** Points to the EXIT menu.

INSERT/ASSEMBLE AUTO EDIT SET UP menu

| Key | Key designation | Description |
|-----|---|---|
| F1 | TIMING* ¹ For setting the edit timing. | <p>Sets the timing at which to record the fields at the edit IN point and OUT point. This timing can be set by pressing the F1 key and the F key together.</p> <p>F1: Editing starts from the odd-numbered field at the IN point, and it ends when an even-numbered field one frame before the OUT point is recorded.</p> <p>F2: Editing starts from the even-numbered field at the IN point, and it ends when an odd-numbered field at the OUT point is recorded.</p> <p>F1/F2: The fields for the edit IN point and OUT point are determined by the timing at which the edit command is issued. If the edit timing command is issued in an even-numbered field, editing is ended in an odd-numbered field; conversely, if the edit timing command is issued in an odd-numbered field, editing is ended in an even-numbered field. However, the F1 setting is forcibly established when manual editing is performed using this unit alone. Bear in mind that if mutually different settings have been selected, the setting selected last takes precedence.</p> <p>●The timing can also be set using the F1 (TIMING) key of the MANUAL SET UP menu.</p> |
| F2 | V PREV Video preview. | <p>Selects the video signals for preview duration (between IN and OUT points).</p> <p>VVV: Monitors video input signals.</p> <p>VBV: Monitors black signals.</p> |
| F3 | A PREV Audio preview. | <p>Selects the audio signals for preview duration (between IN and OUT points).</p> <p>SSS: Monitors audio input signals.</p> <p>SMS: Monitors mute sound.</p> |
| F4 | PLR SYNC Player synchronization. | <p>Sets whether to activate the phase synchronization function in deck-to-deck editing and set the editing accuracy to ± 0 (when TC is selected).</p> <p>ON: The phase synchronization function is activated, and the editing accuracy is set to ± 0 (when TC is selected). However, when CF does not match during editing in the CF mode, the player's IN point is forcibly incremented by $+1$–$+3$ (when 8F is set).</p> <p>OFF: The phase synchronization function is not activated.</p> |
| F5 | PREROLL For setting the preroll time. | <p>Sets the preroll time in 1-second increments. Any time from 0 to 30 seconds can be selected. (Initial setting is 5 seconds.)</p> |
| F6 | POSTROLL For setting the postroll time. | <p>Sets the postroll time in 1-second increments. Any time from 0 to 30 seconds can be selected. (Initial setting is 2 seconds.)</p> |
| F7 | REACTION For compensating the time with a time lag | <p>Compensates the reaction time after the ENTRY button is pressed until the actual operation. Compensation from 0 to 30 frames*² in 1-frame increments can be provided. (Initial setting is 0 frame.)</p> <p>●When an edit point has been set by the ENTRY button, the value obtained after subtracting the reaction time from the moment when the button was pressed becomes the edit point.</p> <p>Operation</p> <ol style="list-style-type: none"> 1. Press the F7 (REACTION) key. 2. Adjust with the ADJUST control. 3. Press the F7 key. |

*¹This item cannot be displayed when the 1080/23p, 1080/24p, 1080/25p or 720/59p format has been selected. (It is forcibly set to F1.)

*²This range differs depending on the format used.

INSERT/ASSEMBLE AUTO EDIT SET UP menu

| Key | Key designation | Description |
|-----|---|---|
| F8 | EXIT | Returns the VTR to the AUTO EDIT menu screen. |
| F9 | DLY STRT Delay start. | Sets the timing after the playback command was issued until the actual operation in 1-frame increments. (This is used to facilitate the synchronization with another VTR which has a different servo reference.) The timing can be set from <u>-30 frames to +30 frames</u> *1 in 1-frame increments. (Initial setting is 0 frame.) (With a “-” value, the operation is performed earlier, and the preroll time is compensated for in the LOCAL mode. With a “+” value, the operation is performed later, and it takes effect both in the REMOTE and LOCAL modes.) |
| F10 | TRACKING For adjusting the tracking. | At normal times, tracking adjustment is not necessary. Adjustment is made if tracking disparities have occurred during editing. VAR: The tracking can be adjusted manually. Refer to “Manually adjusting the tracking” (on page 106). FIX: The tracking is fixed. OPT. ONCE: At the initial editing after the cassette has been inserted, the tracking is optimized while the tape is playing back up to the IN point. The tracking is not subsequently optimized. Tracking can be optimized again. Refer to “Automatically adjusting the tracking” (on page 105). When the PLAY button and STAND BY button are pressed together during EDIT/PLAY, the tracking is optimized again, and it is optimized with each EDIT/PLAY operation. OPT. AUTO: The tracking is optimized while the tape is playing back up to the IN point with each editing operation, and it is retained even if the VTR is transferred to another menu. Refer to “Automatically adjusting the tracking” (on page 105). |
| F11 | CAP LOCK For setting the capstan servo lock. | For selecting the capstan servo lock mode during playback. 4F AUTO (8F AUTO: 1080/23p, 1080/24p, 1080/25p, 1080/50i, 576/50i): Assumes the color frame auto lock mode. If discontinuity is produced in the color frame during playback, the unit locks again to a new color frame. 4F FORCE (8F FORCE: 1080/23p, 1080/24p, 1080/25p, 1080/50i, 576/50i): Assumes the color frame forced lock mode. If there is any discontinuity in the color frame during playback, the unit preserves the field sequence at initial lock. 2F: Assumes frame lock mode. ●The capstan servo lock mode can be set in HOME SET UP menu. If the two settings differ, priority is given to the final mode setting. |
| F12 | FD TIME*2 For setting the audio fade time. | Valid when the F13 key is set to X FADE or V FADE. The times that can be set are as follows: 5, 10, 15, 20, 25, 50, 100 ms. (Initial setting is 5 ms.) For the setting procedure, refer to “Setting the audio fade time” (on page 107). |
| F13 | MODE*2 For selecting audio fade editing. | Audio editing can be accomplished while cross-fade editing prior playback audio and input audio or V-fade editing. X FADE: Performs audio cross-fade editing. CUT: Performs cut (normal) editing. V FADE: Performs audio V-fade editing. |

*1This range differs depending on the format used.

*2Only CUT can be selected when TAPE has been selected as the EDIT REC STATE setting. However, FADE can be selected by pressing this key and F key together, in which case the EDIT REC STATE setting is switched to EE1.

INSERT/ASSEMBLE AUTO EDIT SET UP menu

Selecting the preroll time

- (1) Press the F5 (PREROLL) key.
- (2) Set the preroll time using the ADJUST control.
Any time up to 30 seconds can be set.

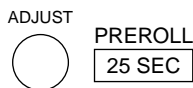

- (3) Press the F5 key.

- If this setting is at variance from the preroll time set on the HOME SET UP menu, the preroll time selected last takes precedence.

Setting DLY START

- (1) Press the F9 (DLY STRT) key.
- (2) Set the time using the ADJUST control.
- (3) Press the F9 key.

- This is set when the VTR's start timing is to be synchronized with the start timing of another VTR in the event that these timings differ.
- When this VTR is used as the master (recorder) in deck-to-deck operations, adjustment can be made in either the "+" or "-" direction, but when the VTR is used in the remote mode (when a controller is connected or this VTR is used as the player in deck-to-deck operations), adjustment can be made in the "+" (delay) direction only.

Setting EDIT REC INHIBIT

The procedure is the same as for the INSERT/ASSEMBLE MANUAL EDIT SET UP menu (on page 98).

SET UP menu

This menu is displayed by pressing the following key: **SET UP**

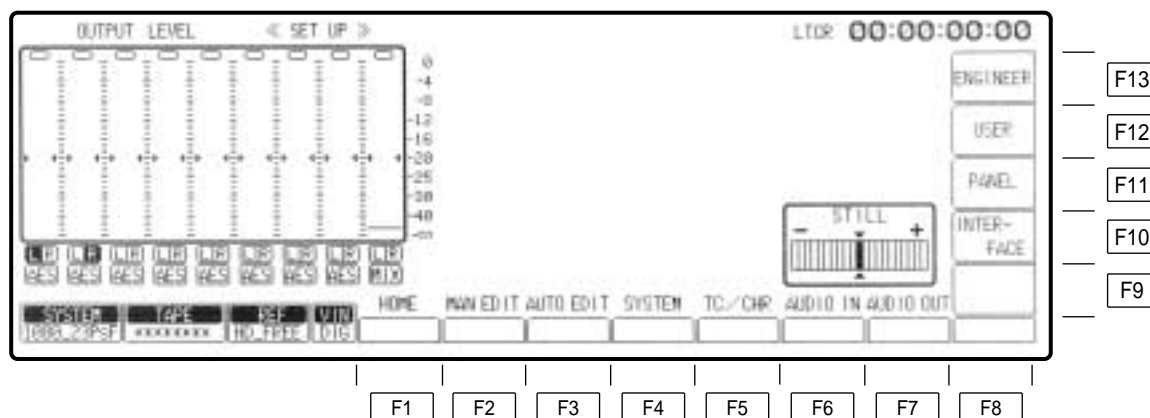

| Key | Key designation | Description |
|-------|-----------------|--|
| F1 | HOME | Transfers the VTR to the HOME SET UP menu screen. |
| F2 | MAN EDIT | Transfers the VTR to the INSERT/ASSEMBLE MANUAL EDIT SET UP menu screen. |
| F3 | AUTO EDIT | Transfers the VTR to the INSERT/ASSEMBLE AUTO EDIT SET UP menu screen. |
| F4 | SYSTEM | Transfers the VTR to the SYSTEM SET UP menu screen. |
| F5 | TC/CHR | Transfers the VTR to the TC/CHR SET UP menu screen. |
| F6 | AUDIO IN | Transfers the VTR to the AUDIO IN SET UP menu screen. |
| F7 | AUDIO OUT | Transfers the VTR to the AUDIO OUT SET UP menu screen. |
| F8-F9 | — | |
| F10 | INTERFACE | Transfers the VTR to the INTERFACE SET UP menu screen. |
| F11 | PANEL | Transfers the VTR to the PANEL SET UP menu screen. |
| F12 | USER | Transfers the VTR to the USER SET UP menu screen. |
| F13 | ENGINEER* | Transfers the VTR to the ENGINEER SET UP menu screen. |

*The ENGINEER menu is displayed by pressing the F and F13 keys at the same time.

INTERFACE SET UP menu

This menu is displayed by pressing the following keys: **SET UP** → **F10**

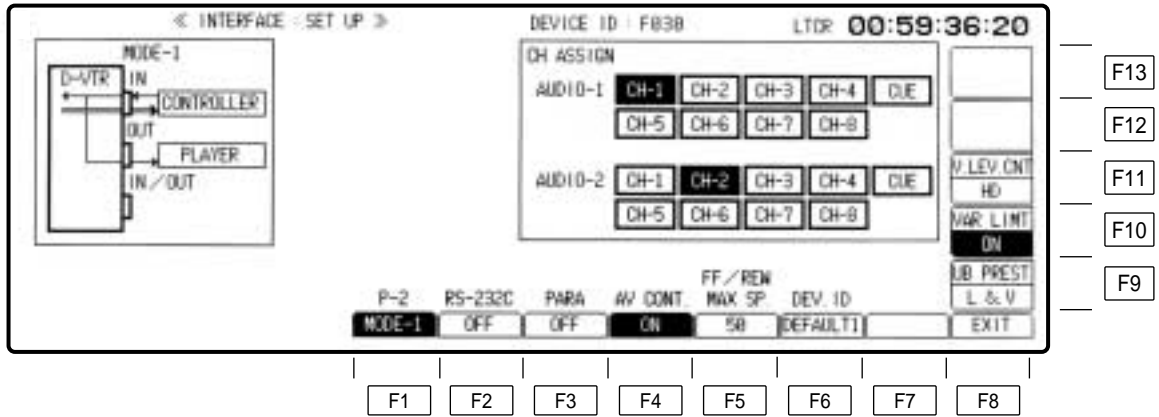

INTERFACE SET UP menu

| Key | Key designation | Description |
|-----|--|--|
| F1 | P-2 RS-422A Control mode setting. | When the component connected to the RS-422A REMOTE connector is to be operated by remote control, one of four modes can be selected to match the system configuration. The flow of the signals in each mode is displayed on the menu. (Refer to "Correlation between modes and connectors" (on page 125).) MODE-1: The VTR connected to the REMOTE OUT or REMOTE IN/OUT connector is controlled. MODE-2: Two or more VTRs are controlled in the same mode as this unit. MODE-3: The VTR connected to the REMOTE OUT connector can be controlled. MODE-4: Two or more VTRs can be controlled in the same mode as this unit. OFF: No control is exercised using RS-422A. |
| F2 | RS-232C | ON: Enables parameter settings and control. OFF: Disables parameter settings and control. BAUD RATE: Baud rate settings. The following baud rates can be set: 300, 600, 1200, 2400, 4800, and 9600. DATA LENGTH: Data length setting. Data lengths 7 and 8 can be set. START BIT: Start bit setting. Start bit 1 (fixed). STOP BIT: Stop bit setting. Start bits 1 and 2 can be set. PARITY: Parity bit setting. Parity bits are NON, ODD and EVEN. |
| F3 | PARA 50P parallel remote ON/OFF. | ON: Enables control. OFF: Disables control. |
| F4 | AV CONT. V/A control. | ON: Enables control from the V/A controller. OFF: Disables control from the V/A controller. The AV control parameter is fixed at the baud rate of 1200 bps. |
| F5 | FF/REW MAX SP FF/REW maximum speed setting. | Tape speed at FF or REW can be set at $\times 50$ or $\times 32$. 50: Maximum tape speed at FF/REW can be set at ± 50 times. 32: Maximum tape speed at FF/REW can be set at ± 32 times. |
| F6 | DEV. ID Device type. | Can be set by pressing the C, F and F6 keys simultaneously. Enables selection of the device ID returned to controller via RS-422A. There are 6 types of device ID: DEFAULT1, DEFAULT2, ID-1, ID-2, ID-3 and USER. Select ID to match the controller in use. To change the USER setting device ID, consult with service personnel. DEFAULT1: "F*130" is returned. (e.g. "F030" will be returned when the system frequency is 59 Hz.) DEFAULT2: "F*24C" is returned. ID-1: "4*103" is returned. ID-2: "0*120" is returned. ID-3: "F*119" is returned. USER: "Optional user setting" is returned. |

*1When the system frequency is 50 Hz or 25 Hz, "1" will replace the asterisk and "0" will replace it for all other frequencies.

*2When the system frequency is 23 Hz or 24 Hz, "2" will replace the asterisk, "1" will replace when it is 50 Hz or 25 Hz, and "0" will replace the asterisk for all other frequencies. However, even though the system frequency is 23 Hz, "0" will replace when the 30TC is selected as the RC_TC setting. (See page 86.)

INTERFACE SET UP menu

| Key | Key designation | Description |
|---------|---|---|
| F7 | PREREAD*1 For setting pre-read from the remote commands. | The setting can be changed by pressing the F7 key while holding down the F key. VIDEO: Video pre-read can be set. AUDIO: Audio pre-read can be set. V&A: Both video and audio pre-read can be set. |
| F8 | EXIT | Returns the VTR to the SET UP menu screen. |
| F9 | UB PRESET For setting the UB preset from remote. | Selects the setting destination for the TCG UB preset command supplied from the external source (RS-422/232C). L&V: Sets the destination for LTC UB and VITC UB. LTC: Sets the destination for LTC UB only. VITC: Sets the destination for VITC UB only. |
| F10 | VAR LIMT*2 | Selects the limit speed for the VAR command supplied from the external source (RS-422/232C). This item can be set by pressing the F10 key and F key together. ON: The tape speed is limited to the range from $-1x$ to $+2x$ normal speed. OFF: The tape speed is limited to the range from $-1.5x$ to $+2.5x$ normal speed. (At speed above $2x$ or so or below $-1x$, pictures are searched without AT ON TRACK.) |
| F11 | V. LEV. CNT | Selects whether to vary the VTR HD/SD output in response to an external video component adjustment command (RS-422, V/A controller). NORMAL: Identifies HD/SD commands and varies the level of each. HD: Varies HD output level forcibly. SD: Varies SD output level forcibly. BOTH: Varies This is varied in tandem with the HD output/SD output level. |
| F12-F13 | — | |

*1 This item appears only when an SD format (525/59i or 625/50i) is used as the system format.

*2 <Note>

Set this item to OFF for slow editing with the unit connected to an editing controller (such as the BVE-9100). Phase synchronization may not be possible with slow editing near the $-1x$ or $+2x$ speed.

INTERFACE SET UP menu

□ Table of correlations between modes and connectors

| MODE | Connections used when the unit is used as the source unit and operated by remote control by an editor or when editing is performed using a controller (remote) | | | Connections used when editing is performed by operating the controls on the unit's front panel (local) | | |
|--------|--|----------|------------|--|----------|----------|
| | IN | OUT | IN/OUT | IN | OUT | IN/OUT |
| MODE-1 | Controller | Player 1 | Disabled | Disabled | Player 1 | Disabled |
| MODE-1 | Controller | Player 1 | Disabled | Disabled | Disabled | Player 2 |
| MODE-2 | Controller | Player 1 | Disabled | Disabled | Disabled | Disabled |
| MODE-3 | Disabled | Player 1 | Controller | Disabled | Player 1 | Disabled |
| MODE-3 | Disabled | Player 1 | Controller | Disabled | Disabled | Player 2 |
| MODE-4 | Disabled | Player 1 | Controller | Disabled | Disabled | Disabled |

MODE-1 connection diagram

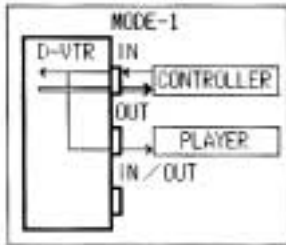

◁ — Command
 ◁ = Return data

MODE-2 connection diagram

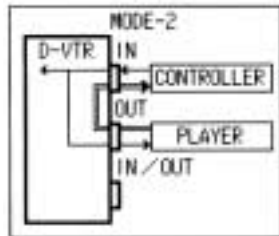

MODE-3 connection diagram

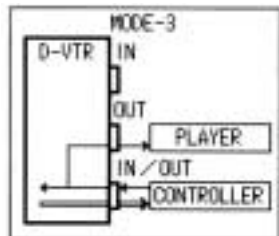

MODE-4 connection diagram

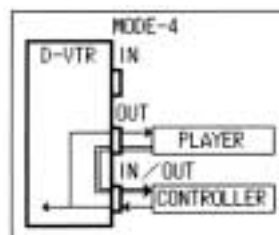

INTERFACE SET UP menu

□ Setting the RS-232C parameters

- (1) Press the F2 (RS-232C) key to set it ON.
The parameter display now appears.

BAUD RATE: 300, 600, 1200, 2400, 4800, 9600 bps
DATA LENGTH: 7 or 8 bits
START BIT: 1 bit, fixed
STOP BIT: 2 or 1 bit
PARITY: None, odd or even

- (2) Press the center cursor key.
The input area now blinks.
- (3) Press the cursor keys to select the input area.
The cursor moves on a block by block basis when the F key and cursor key are pressed together.

BAUD RATE:

- (4) Press the center cursor key to set the parameter.

BAUD RATE:

- (5) Press the ENT key to enter the setting.

□ Setting the V/A control parameters

The AV control parameter is fixed at the baud rate of 1200 bps.

INTERFACE SET UP menu

□ Setting the CH ASSIGN audio channel

The commands from a controller which has only analog audio CH1 and CH2 preset commands can be re-read and allotted to the digital audio CH1 to CH4 (or CH1 to CH8 with an 8-channel format) and CUE channels.

- (1) Press the center cursor key to display the cursor.
The input area now blinks.

- (2) Move the cursor to the CH ASSIGN block by pressing the F key and cursor key together.

| | | | | | |
|---------|-----------------------------------|----------------------|----------------------|----------------------|----------------------|
| AUDIO-1 | <input type="text" value="CH-1"/> | <input type="text"/> | <input type="text"/> | <input type="text"/> | <input type="text"/> |
| AUDIO-2 | <input type="text"/> | <input type="text"/> | <input type="text"/> | <input type="text"/> | <input type="text"/> |

- (3) Press the cursor key to move the cursor to the position of the channel to be selected.

| | | | | | |
|---------|----------------------|-----------------------------------|----------------------|----------------------|----------------------|
| AUDIO-1 | <input type="text"/> | <input type="text" value="CH-2"/> | <input type="text"/> | <input type="text"/> | <input type="text"/> |
| AUDIO-2 | <input type="text"/> | <input type="text"/> | <input type="text"/> | <input type="text"/> | <input type="text"/> |

- (4) Press the center cursor key to set the display ON or OFF.
At ON, the channel will appear in reverse video.

| | | | | | |
|---------|----------------------|-----------------------------------|----------------------|----------------------|----------------------|
| AUDIO-1 | <input type="text"/> | <input type="text" value="CH-2"/> | <input type="text"/> | <input type="text"/> | <input type="text"/> |
| AUDIO-2 | <input type="text"/> | <input type="text"/> | <input type="text"/> | <input type="text"/> | <input type="text"/> |

- (5) Press the ENT key to enter the setting.

PANEL SET UP menu

This menu is displayed by pressing the following keys: **SET UP** → **F11**

The screenshot shows the 'PANEL SET UP' menu with various settings and function key callouts:

- OUTPUT LEVEL:** A vertical scale from 0 to -40 dB with a slider set to approximately -12 dB.
- CLUTCH:** OFF
- MAX SP:** -1***2 (Callout F12)
- OP MAP:** (Callout F11)
- UNITY LG:** (Callout F10)
- WLL AS-V:** (Callout F9)
- TO INPUT:** STANDARD
- EXIT:** (Callout F13)
- STILL:** A horizontal scale from - to + with a slider set to 0.
- KEY:** OFF
- ALARM:** OFF
- JOG:** MAX SP: -1***2 (Callout F3)
- SHTL:** L/C/R X 8 X 4: ON (Callout F4), OFF (Callout F5)
- MAX SP: A SCALE:** 50 (Callout F6), -20 dB (Callout F7)
- SYSTEM:** TAP: ***** (Callout F1)
- REF:** TAP: ***** (Callout F2)
- WIN:** TAP: ***** (Callout F8)

PANEL SET UP menu

| Key | Key designation | Description |
|-----|--|--|
| F1 | SOUND KEY Selection of click sound for function keys and IN/OUT keys. | OFF: No click sound. HIGH: Loud click sound. LOW: Soft click sound. |
| F2 | SOUND ALARM Selection of warning sound when error occurs. | OFF: No warning sound. HIGH: Loud warning sound. LOW: Soft warning sound. |
| F3 | JOG MAX SP. Jog maximum speed. | -2 ← → +2: Speed range from $-2\times$ to $+2\times$. -1 ← → +1: Speed range from $-1\times$ to $+1\times$. -1 ← → +2: Speed range from $-1\times$ to $+2\times$. |
| F4 | SHTL L/C/R Shuttle dial clutch ON/OFF. | OFF: No clutch. (F5 key also goes off.) ON: Clutch set at three points: left edge, center and right edge. |
| F5 | SHTL $\times 8$, $\times 4$ Selection of shuttle dial a8, a4 clutch. | OFF: No clutch. $\times 8$: Clutch set at ± 8 speed positions. $\times 4$, $\times 8$: Clutch set at four positions: $\pm 4\times$ speed and $\pm 8\times$ speed. $\times 4$ Clutch set at $\pm 4\times$ speed positions. |
| F6 | SHTL MAX SP. Shuttle maximum speed. | 50: The maximum shuttle speed is set to $50\times$ normal playback. 32: The maximum shuttle speed is set to $32\times$ normal playback. 16: The maximum shuttle speed is set to $16\times$ normal playback. |
| F7 | A.SCALE Audio level meter scale setting. | -20 (-18) dB: Scale marker of level meter is set to -20 (-18) dB.* 0 dB: Scale marker of level meter is set to -0 dB. *The setting will be -18 dB when the audio reference level has been set to -18 dB. |
| F8 | EXIT | Returns the VTR to the SET UP menu screen. |
| F9 | TC INPUT Time code input mode | STANDARD: In this mode, the time code is input starting from the first of the two hour digits. REVERSE: In this mode, the time code is input starting from the frame digits. These settings are valid in all modes in which the time code can be input manually. |
| F10 | UNITY LD | ALL A&V: Lamp lights when UNITY is set for all the digital audio record/playback system levels and the video playback system levels (excluding SYSTEM system levels). AUDIO PB: Lamp lights when all digital audio playback system levels are at unity. |
| F11 | OP MAP | Transfers the VTR to the OP MAP REMOTE menu screen. |
| F12 | VAR MAX SP. Variable maximum speed. | -1 ← → +2: Speed range from $-1\times$ to $+2\times$. -1 ← → +1: Speed range from $-1\times$ to $+1\times$. 0 ← → +1: Speed range from $0\times$ to $+1\times$. |
| F13 | VAR CLUTCH Variable mode clutch ON/OFF. | ON: Clutch set at $-1/0/+1/+2\times$ speed positions. OFF: No clutch. |

PANEL SET UP (OP MAP REMOTE) menu

Press the **SET UP** → **F11** → **F11** keys to display the OP MAP REMOTE menu.

This menu is used to set and display the buttons, keys, controls, etc. which can be operated on the unit's front panel in the remote mode.

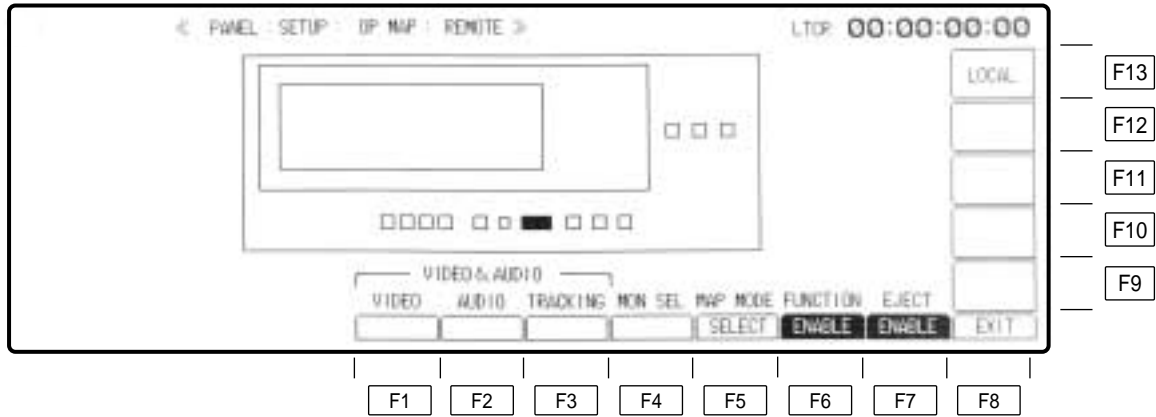

PANEL SET UP (OP MAP REMOTE) menu

| Key | Key designation | Description |
|--------|--|--|
| F1 | VIDEO For adjusting the video level. | Selects the VIDEO OUT menu level adjustment function. When the key is pressed, the display is highlighted. |
| F2 | AUDIO For adjusting the audio level. | Selects the AUDIO REC and PB level adjustment function. When the key is pressed, the display is highlighted. |
| F3 | TRACKING For selecting the tracking adjustment. | Selects the tracking adjustment. When the key is pressed, the display is highlighted. |
| F4 | MON SEL For selecting the monitor. | Selects the L/R selector button for monitoring the audio signals. When the key is pressed, the display is highlighted. |
| F5 | MAP MODE For enabling key operations. | ALL: All the keys can be operated by remote control. SELECT: The selected keys can be operated by remote control. |
| F6 | FUNCTION For enabling or disabling all the functions. | ENABLE: All the functions are enabled. DISABLE: All the functions are disabled. |
| F7 | EJECT For enabling or disabling the operation of the EJECT button during remote control operations. | ENABLE: Eject operations are enabled. DISABLE: Eject operations are disabled. |
| F8 | EXIT | Returns the VTR to the SET UP menu screen. |
| F9–F12 | — | |
| F13 | LOCAL | Transfers the VTR to the OP MAP LOCAL menu screen. |

PANEL SET UP (OP MAP REMOTE) menu

□ Correlation between F5 (MAP MODE) and F6 (FUNCTION) keys

| F5 (MAP MODE) | F6 (FUNCTION) | Description of setting | |
|---------------|---------------|--|--|
| | | Operation keys (STOP, PLAY, etc.) | Function keys (F1 to F13, controls, etc.) |
| ALL | ENABLE | Regardless of this menu's settings, all settings are enabled. | Regardless of this menu's settings, all settings are enabled. |
| | DISABLE | Regardless of this menu's settings, all settings are disabled. | Regardless of this menu's settings, all settings are disabled. |
| SELECT | ENABLE | Only keys selected on this menu enabled. | Only functions selected by F1 to F4 on this menu and other specific functions enabled. |
| | DISABLE | Regardless of this menu's settings, all settings are disabled. | As above. |

<Notes>

- Even when the F6 key has been set to ENABLE on this menu, its setting will be changed to DISABLE if the unit is in the remote control mode and it receives the LOCAL DISABLE command.
(The EJECT button acts in accordance with the F7 (EJECT) key setting.)
- At the time of shipment, the F6 key was set to ENABLE and the F5 key to SELECT.

□ OP MAP setting method

- Those buttons and keys which are marked on the graphics of the control panel shown on the display correspond to the buttons on the actual control panel.
The part corresponding to a key or button which has been pressed on the control button is highlighted.
- When the JOG, VAR or SHTL button is pressed, the search dial appears.
- When the F1 (VIDEO) key is pressed, the ADJUST control appears.
- When the F2 (AUDIO) key is pressed, the ADJUST control appears.
- When the F3 (TRACKING) key is pressed, the ADJUST control appears.
- When the F4 (MON SEL) key is pressed, the L/R button appears.

PANEL SET UP (OP MAP LOCAL) menu

Press the [SET UP] → [F11] → [F11] → [F13] keys to display the OP MAP LOCAL menu.

This menu is used to set and display the buttons, keys, controls, etc. which cannot be operated on the unit's front panel in the local mode.

The menu serves to prevent settings or adjustment values from being changed when the corresponding button, key or control is touched by mistake.

- With the initial setting, all operations are enabled.

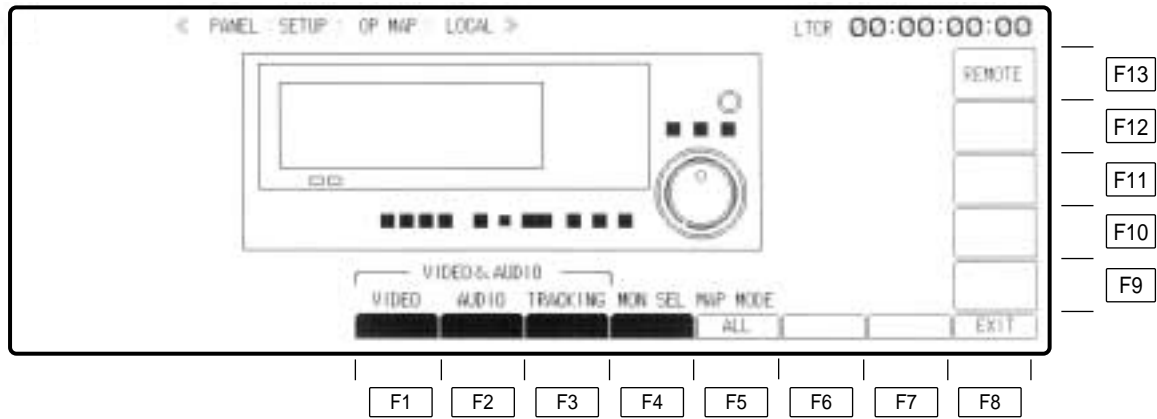

PANEL SET UP (OP MAP LOCAL) menu

| Key | Key designation | Description |
|--------|--|---|
| F1 | VIDEO For adjusting the video level. | Selects the VIDEO OUT menu level adjustment function. When the key is pressed, the display is highlighted. |
| F2 | AUDIO For adjusting the audio level. | Selects the AUDIO REC and PB level adjustment function. When the key is pressed, the display is highlighted. |
| F3 | TRACKING For selecting the tracking adjustment. | Selects the tracking adjustment. When the key is pressed, the display is highlighted. |
| F4 | MON SEL For selecting the monitor. | Selects the L/R selector button for monitoring the audio signals. When the key is pressed, the display is highlighted. |
| F5 | MAP MODE For enabling key operations. | ALL: Regardless of the OP MAP settings, operation of all the functions is enabled. SELECT: Operation of the only the functions to be selected in the OP MAP mode is enabled. |
| F6–F7 | — | |
| F8 | EXIT | Returns the VTR to the SET UP menu screen. |
| F9–F12 | — | |
| F13 | REMOTE | Transfers the VTR to the OP MAP REMOTE menu screen. |

OP MAP setting method

- Those buttons and keys which are marked on the graphics of the control panel shown on the display correspond to the buttons on the actual control panel.
The part corresponding to a key or button which has been pressed on the control button is highlighted.
- When the JOG, VAR or SHTL button is pressed, the search dial appears.
- When the F1 (VIDEO) key is pressed, the ADJUST control appears.
- When the F2 (AUDIO) key is pressed, the ADJUST control appears.
- When the F3 (TRACKING) key is pressed, the ADJUST control appears.
- At the time of shipment, the F5 (MAP MODE) key was set to ALL so that all the keys, buttons, etc. are operational.

USER SET UP menu

This menu is displayed by pressing the following keys: **SET UP** → **F12**

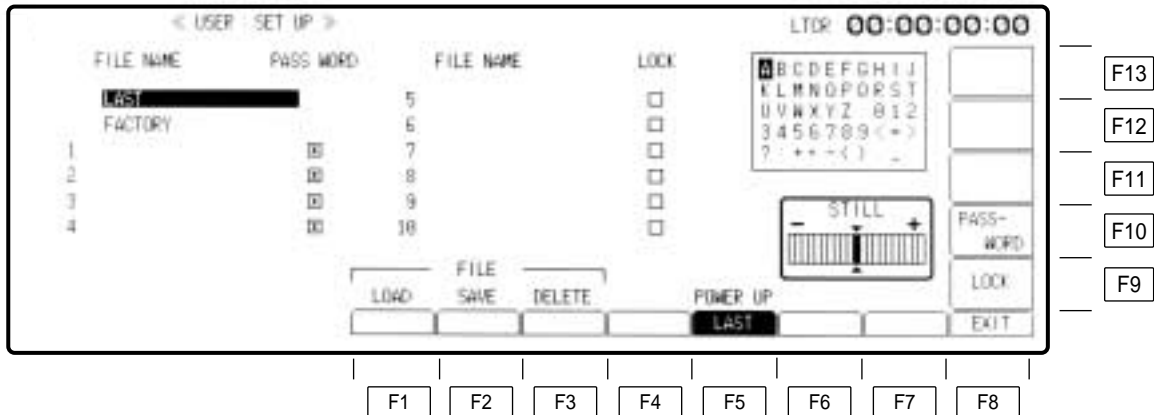

•User files (SET UP menu)

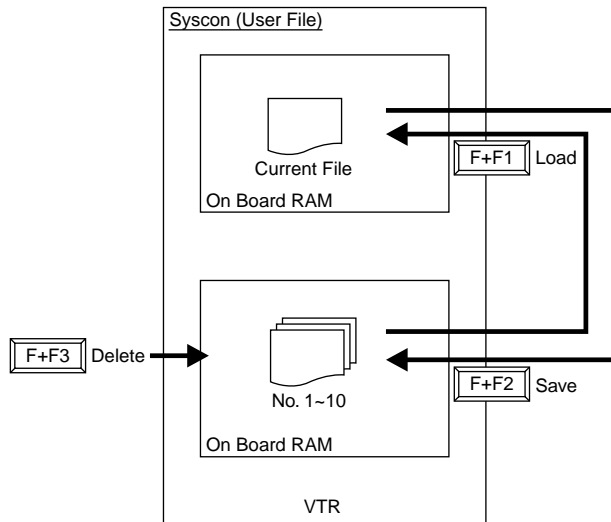

<SET UP: USER menu function settings>

| Key | Key designation | Description |
|---------|---|--|
| F1 | LOAD For loading user files. | Press together with F key. This calls the selected user files. |
| F2 | SAVE For saving user files. | Press together with F key. This saves the selected user files. |
| F3 | DELETE For deleting user files. | Press together with F key. This deletes the selected user files. |
| F4 | — | |
| F5 | POWER UP Sets the file to be loaded when the power is turned on. | LAST: Call last file FACTORY: Call factory file* 1 to 10: Calls user file. |
| F6-F7 | — | |
| F8 | EXIT | Returns the VTR to the SET UP menu screen. |
| F9 | LOCK For locking files. | Press together with F key. File selected with cursor locks and cannot be renewed or deleted. Press again to release the lock. Use with user files 5 to 10. |
| F10 | PASSWORD Password. | Used to set or release the lock mode for files 1 to 4 with a password. After this key is pressed, the 4-character password is input. |
| F11-F13 | — | |

*The items set using F1 to F7 on the SYSTEM SET UP menu (on pages 141 and 143) are not rewritten even if the factory files are loaded.

USER SET UP menu

□ Saving user files

Twelve files are provided in this unit.

Two of these files are reserved: the LAST file containing the statuses established when the power was last turned off, and the FACTORY file containing the factory statuses (initial settings). These two files cannot be deleted or updated.

The other 10 files are available as user files for storing the menu settings selected by the user. They can be called, deleted or updated as desired.

(1) Set to the state in which the menu settings are to be saved.

- When UNITY and VAR settings are provided, the VAR values will also be saved even if the UNITY setting has been selected.

(2) Press the cursor keys to select the number of the desired file.

```
                FACTORY
1  [ ]          [ * ]
2  [ ]          [ * ]
3  [ ]          [ * ]
4  [ ]          [ * ]
```

The cursor appears at the place which was designated last.

(3) Input the filename.

Up to 20 characters can be input.

1. EDITOR 1

(4) Press the F key and F2 (SAVE) key together to save the file.

Inputting the filename

```
A B C D E F G H I J
K L M N O P Q R S T
U V W X Y Z 0 1 2
3 4 5 6 7 8 9 < = >
? ; + , - ( ) . _
```

- 0 to 9: Press the number keys.

- To enter a letter of the alphabet, proceed as follows.

- 1) Press the center cursor key.
- 2) Use the ADJUST control to move the column cursor to the left or right, and select the desired character.

When the F key and cursor key are pressed together, the cursor can be moved up or down or to the left or right.

- 3) When the ENT key is pressed, the character above the cursor is input.
- 4) Press the center cursor key to complete the character input.
- 5) Press the F key and F2 (SAVE) key together to save the file.

- To correct a character, press the BS key.

To redo the entire input, press the C key.

A password is required to access files 1 to 4.

- (1) Press the F10 (PASSWORD) key.

- (2) Input a password consisting of 4 characters.

- For details on the password, consult your servicing engineer.

USER SET UP menu

Locking user files

When locked, the files are protected from subsequent attempts to delete or update their data.

- (1) Press the cursor keys to select the file to be locked.

1. EDITOR 1

- (2) Input the password for files 1 to 4.

For files 5 to 10, press the F key and F9 key together.

When a file is locked, its display is shown in reverse video.

1. EDITOR 1

- When files are to be unlocked:

When the password is input for files 1 to 4, the files are unlocked.

1. Press the cursor keys and select the file to be unlocked.

2. Press the F10 (PASSWORD) key.

3. Input the 4-character password.

If the input password is correct, the file is unlocked.

If it is incorrect, the file will not be unlocked.

When the F key and F9 key are pressed together again, files 5 to 10 are unlocked.

1. EDITOR 1

Updating user files

- (1) Press the cursor keys to select the file to be updated.

- If the file is locked, unlock it.

1. EDITOR 1



↑ Unlocked

(the file must be unlocked
if the display is in reverse video)

- (2) Change the contents of the file.

For instance, press the F4 (TC/CTL) key on the HOME menu and change TC to CTL1.

- (3) Press the F key and F2 (SAVE) key together. Then press the F4 (TC/CTL) key on the HOME menu and change to TC again.

The changed setting is now saved in the file.

When the F key and F1 (LOAD) key are pressed together and the HOME button is pressed to display the HOME menu, the setting of the F4 (TC/CTL) key which was changed above will have been changed to CTL1.

- The pre-updated setting is cleared.

USER SET UP menu

Deleting user files

Unnecessary files can be deleted.

(1) Press the cursor keys to select the file to be deleted.

5. EDITOR 2 (File locked)

(2) Check that the file to be deleted is unlocked.

If it is locked, refer to the section on locking the user files, and unlock the file.

5. EDITOR 2 (Lock released)

(3) Press the F key and F3 (DELETE) key together.

The file is now deleted.

•A locked file cannot be deleted unless it is first unlocked.

Calling user files

Files saved in the memory can be called.

(1) Press the cursor keys to select the file to be called.

1. EDITOR 1

(2) When the F key and F1 (LOAD) key are pressed together, the file is called.

Check the called file.

Automatically calling a file when the power is switched on

When the power is switched on, a file can be called automatically.

(1) Press the F5 (POWER UP) key.

Each time this key is pressed, a file is called.

The selected file is called automatically the next time the power is turned on.

•The LAST file serves as the initial setting.

USER SET UP menu

Copying user filenames

When a file is to be given the same name, the filename is copied.

(1) Press the cursor keys to select the filename to be copied.

1. EDITOR 1

(2) Press the FROM key.

1. EDITOR 1

(3) Press the cursor keys to select the number of file serving as the copy destination.

5.

(4) Press the COPY key. The filename is copied.

5. EDITOR 1

(5) Press the F and F2 (SAVE) key together.

• This function copies the filename only.

Bear in mind that the contents of the file cannot be copied.

SYSTEM SET UP menu

This menu is displayed by pressing the following keys: **SET UP** → **F4**
 The system format and video output format currently set in the menu are displayed.

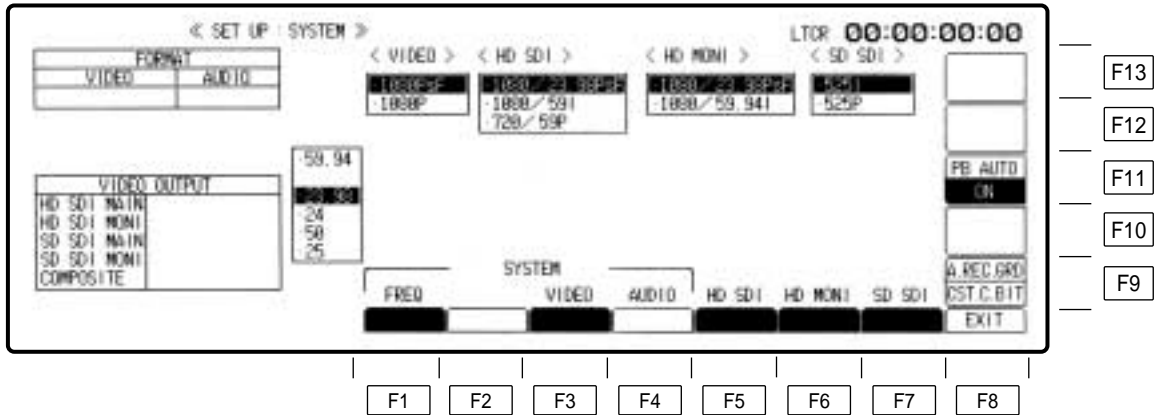

SYSTEM SET UP menu Refer to the setting flowchart and output status tables on pages 144 and 145.

As indicated in the procedures below, select the system frequency, video recording format, audio recording format, and output formats for the output connectors to set the system format.

| Key | Key designation | Description |
|-----|--|---|
| F1 | FREQ* For selecting the SYSTEM frequency. | For selecting the system frequency. When the F1 key is pressed, the frequency selection window is opened. The frequency can now be selected using the cursor keys. 59.94: The 59.94 Hz system is selected. 23.98: The 23.98 Hz system is selected. 24: The 24 Hz system is selected. 50: The 50 Hz system is selected. 25: The 25 Hz system is selected. The selection is entered by pressing the ENT key. When "59.94" or "50" has been selected, the video recording format selection window is opened. When the 23.98, 24 or 25 setting has been selected, a window enabling PsF or P (Non-PsF) to be selected is opened. |
| F2 | — | |
| F3 | VIDEO For selecting the video recording format. | For selecting the video recording format. When the F3 key is pressed, the video recording format selection window is opened. Use the cursor keys to select the format. One of the following menu items is selected when 59.94 has been selected as the system frequency setting. 1080i: The 1080/59.94i recording format is selected. 525i: The 525/59.94i recording format is selected. 720P: The 720/59.94p recording format is selected. Similarly, one of the following menu items is selected when "50" has been selected as the system frequency setting. 1080i: The 1080/50i recording format is selected. 625i: The 625/50i recording format is selected. The selection is entered by pressing the ENT key. When "1080i" or "720P" has been selected, the audio recording format selection window is opened. Select either PsF or P when 23.98, 24 or 25 has been selected as the system frequency setting. To enter the selection, press the ENT key. |

*The FREQ setting is acknowledged only in the status where the cassette has been ejected.
If an attempt has been made to change this setting while a cassette is still inserted, the "EJECT CASSETTE TO CHANGE FORMAT" message appears to warn the user to eject the cassette first.

SYSTEM SET UP menu

| Key | Key designation | Description |
|-----|--|--|
| F4 | AUDIO For selecting the audio recording format. | <p>For selecting the audio recording format. When the F4 key is pressed, the audio recording format selection window is opened. The format can now be selected using the cursor keys (but only when the “1080/59I”, “720/59P” or “480/59I” format has been selected).</p> <p>24bit/8CH: The audio 8-channel format is selected. 20bit/4CH: The audio 4-channel format is selected. The selection is entered by pressing the ENT key. When “720P” has been selected as the system format, the SD SDI MAIN output selection window is opened. When “1080I” has been selected as the system format, the system format is entered, and the selection window is closed.</p> |
| F5 | HD SDI | <p>For selecting the HD SDI MAIN output format. When the F5 key is pressed, the HD SDI MAIN output format selection window is opened. The format can now be selected using the cursor keys (but only when “1080/23.98PsF” or “1080/24PsF” has been selected as the system format).</p> <p>1080/23.98PsF (1080/24PsF): The output is in the 1080/23.98PsF (1080/24PsF) format. 1080/59.94I (1080/60I): The output is in the 1080/59.94i (1080/60i) format. 720/59.94P (720/60P): The output is in the 720/59.94p (720/60p) format.</p> <p>When “1080/23.98PsF (1080/24PsF)” has been selected, the HD SDI monitor output selection window is opened. When “1080/59I” or “720/59P” has been selected, the HD_SD_I_MAIN output selection window is opened. When any other selection is made, it is entered by pressing the ENT key. At the same time, the window is closed</p> |
| F6 | HD MONI | <p>For selecting the format in which the signals are to be output to the HD_SD_I monitor. When the F6 key is pressed, the HD_SD_I monitor output selection window is opened. Use the cursor keys to select the output format. (This format can be selected only when the HD SDI main output has the same setting as the system format and 1080/23.98PsF or 1080/24PsF has been set.)</p> <p>1080/23.98PsF (1080/24PsF): The output is in the 1080/23.98PsF (1080/24PsF) format. 1080/59.94I (1080/60I): The output is in the 1080/59.94i (1080/60i) format.</p> <p>When “1080/23.98PsF (1080/24PsF)” has been selected, the HD SDI MAIN output format selection window is opened. When any other selection is made, it is entered by pressing the ENT key. At the same time, the window is closed.</p> |

By pressing the C key while any of the selection windows are open, it is possible to return the selection status to the previously set data. (Even when data has been entered by pressing the ENT key, operation will still be as described above while the related windows are open.)

SYSTEM SET UP menu

| Key | Key designation | Description |
|---------|-----------------|---|
| F7 | SD SDI | <p>For selecting the format in which the signals are to be output to SD SDI MAIN.</p> <p>When the F7 key is pressed, the HD SDI MAIN output selection window is opened. The output format can now be selected using the cursor keys [but only when “720/59.94P” or “1080/23.98PsF” (same format set for monitor as for HS SDI MAIN) has been selected as the system format.]</p> <p>525I: The output is in the 525i format. 525P: The output is in the 525p format.</p> <p>The selection is entered by pressing the ENT key. At the same time, the window is closed.</p> |
| F8 | EXIT | Returns the VTR to the SET UP menu screen. |
| F9 | A.REC.GRD | <p>Selects the recording/editing inhibit operation during recording/editing by setting the cassette's C bit.</p> <p>CST.C.BIT: If the C bit setting and SYSTEM menu setting are at variance, the VTR is not transferred to the recording/editing operation, and an operation error will appear at the same time.</p> <p>FREE: The VTR is transferred to the recording/editing operation as per the SYSTEM menu setting. If the C bit setting and SYSTEM menu setting are at variance and an attempt is made to execute a recording/editing operation, an operation message will appear.</p> |
| F10 | — | |
| F11 | PB AUTO | <p>Selects whether to select the 4CH or 8CH mode using the cassette's C bit setting during tape playback.</p> <p>ON: The 4CH or 8CH mode is automatically selected during playback using the cassette's C bit setting. (When the C bit is UP, 4CH mode operation is performed; when it is DOWN, 8CH mode operation is performed.) If the tape recording format and the cassette C bit setting are at variance, a warning message will appear.</p> <p>OFF: The tape is played back in the mode set using the SYSTEM menu regardless of the C bit status. If the tape recording format and SYSTEM menu setting are at variance, a warning message will appear.</p> |
| F12-F13 | — | |

SYSTEM SET UP menu

Keys are indicated in the parentheses.

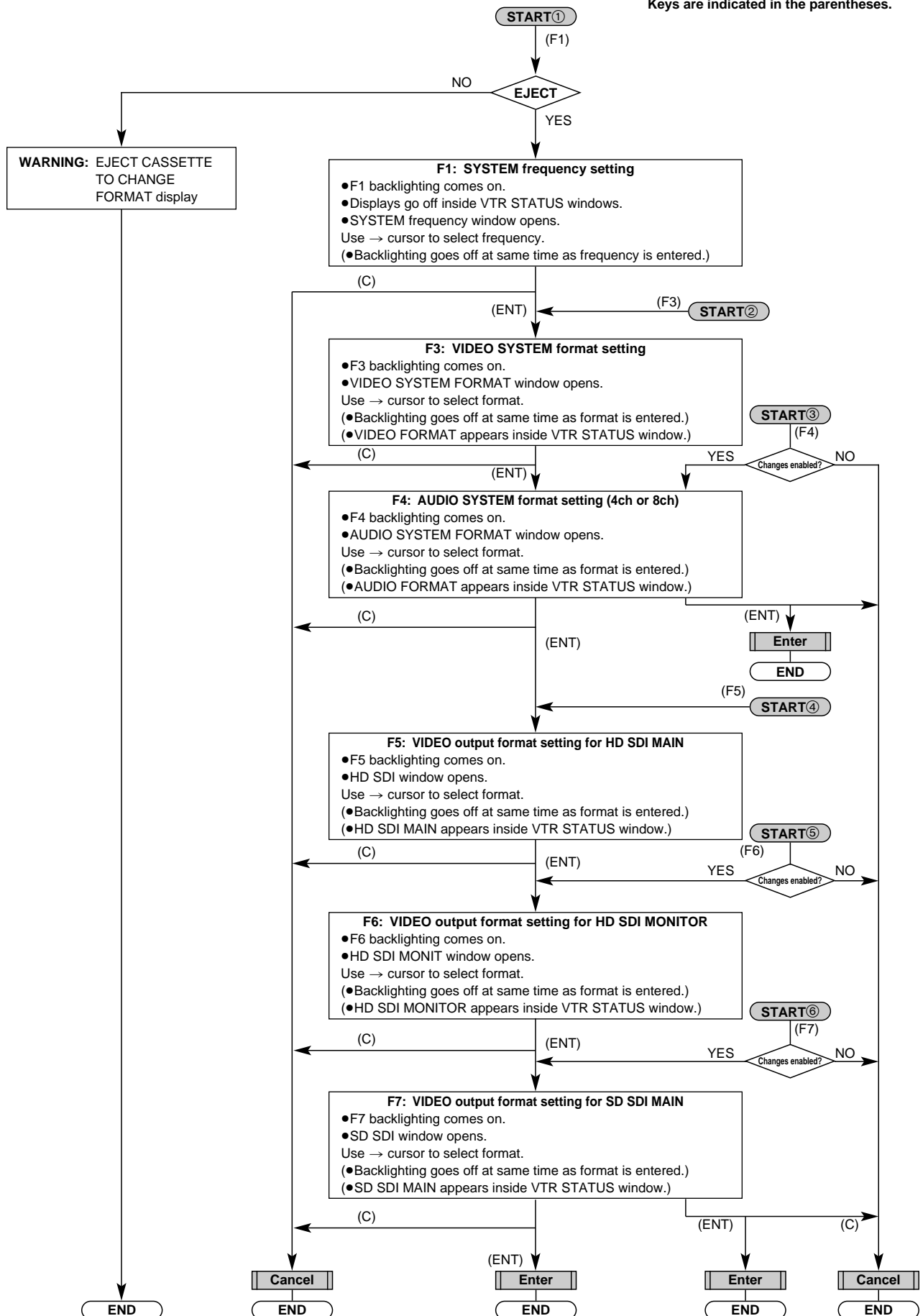

SYSTEM SET UP menu

System format and video output status table

| Optional board AJ-UDC3700AG | System format front setting | | | | | | HD_SDI OUT | HD_MONI OUT | SD_SDI OUT | SD_SDI_MONI | CMPST | REF | | | |
|--------------------------------|-----------------------------|---------------|---------------|---------------|---------------|-------------|---------------|---------------|------------|-------------|------------|------------|--------|------------|----------|
| | FREQ | VIDEO | AUDIO | HD_SDI | HD_MONI | SD_SDI | | | | | | HD_REF | SD_REF | | |
| YES | 59.94 | 1080i | 4ch (20bit) | (1080/59.94i) | (1080/59.94i) | (525i) | 1080/59.94i | 1080/59.94i | 525/59.94i | | | | | | |
| | | | 8ch (24bit) | | | | | | | | | | | | |
| | | 720p | 4ch (20bit) | (720/59.94p) | (720/59.94p) | 525i | 720/59.94p | 720/59.94p | 525/59.94i | 525/59.94i | NTSC | 59.94i | BB59 | | |
| | | | | | | 525p | | | 525/59.94p | | | | | | |
| | | | 8ch (24bit) | 525i | 525/59.94i | | | | | | | | | | |
| | | | | 525p | 525/59.94p | | | | | | | | | | |
| | 525i | 4ch (20bit) | (1080/59.94i) | (1080/59.94i) | (525i) | 1080/59.94i | 1080/59.94i | 525/59.94i | | | | | | | |
| | | 8ch (24bit) | | | | | | | | | | | | | |
| | 23.98 | 1080psf | (8ch (24bit)) | 1080/23.98psf | 1080/23.98psf | 525i | 1080/23.98psf | 1080/23.98psf | 525/59.94i | 525/59.94i | NTSC | | | | |
| | | | | | | 525p | | | 525/59.94p | | | | | | |
| | | | | 1080/59.94i | (1080/59.94i) | (525i) | 1080/59.94i | 1080/59.94i | 525/59.94i | 525/59.94p | 525/59.94i | 525/59.94p | NTSC | 47.96i | BB59 |
| | | | | | | | | | | | | | | | |
| | | | | 720/59.94p | (720/59.94p) | (525i) | 720/59.94p | 720/59.94p | 525/59.94i | 525/59.94p | 525/59.94i | 525/59.94p | NTSC | | |
| | | | | | | | | | | | | | | | |
| | | 1080p | (8ch (24bit)) | (1080/23.98p) | (1080/23.98p) | (525i) | 1080/23.98p | 1080/23.98p | 525/59.94i | | | | | | |
| | | 24 | 1080psf | (8ch (24bit)) | 1080/24psf | 1080/24psf | (****) | 1080/24psf | 1080/24psf | No signals | No signals | No signals | 48.00i | No signals | |
| | | | | | | | | | | | | | | | 1080/60i |
| | | | | | 720/60p | (720/60p) | | 720/60p | 720/60p | | | | | | |
| | 1080p | | (8ch (24bit)) | (1080/24p) | (1080/24p) | | 1080/24p | 1080/24p | | | | | | | |
| | 50 | 1080i | (8ch (24bit)) | (1080/50i) | (1080/50i) | (625i) | 1080/50i | 1080/50i | 625/50i | 625/50i | PAL | 50i | BB50 | | |
| 625i | | (8ch (24bit)) | (625/50i) | (625/50i) | (625i) | | | | | | | | | | |
| 25 | 1080psf | (8ch (24bit)) | 1080/25psf | (1080/25psf) | (625i) | 1080/25psf | 1080/25psf | 1080/25p | 1080/25p | | | | | | |
| | 1080p | | 1080/25p | (1080/25p) | | | | | | | | | | | |

ENGINEER SET UP menu

This menu is displayed when the **SET UP** → **F13** and **F** keys are pressed together, and then press the **F13** key again.

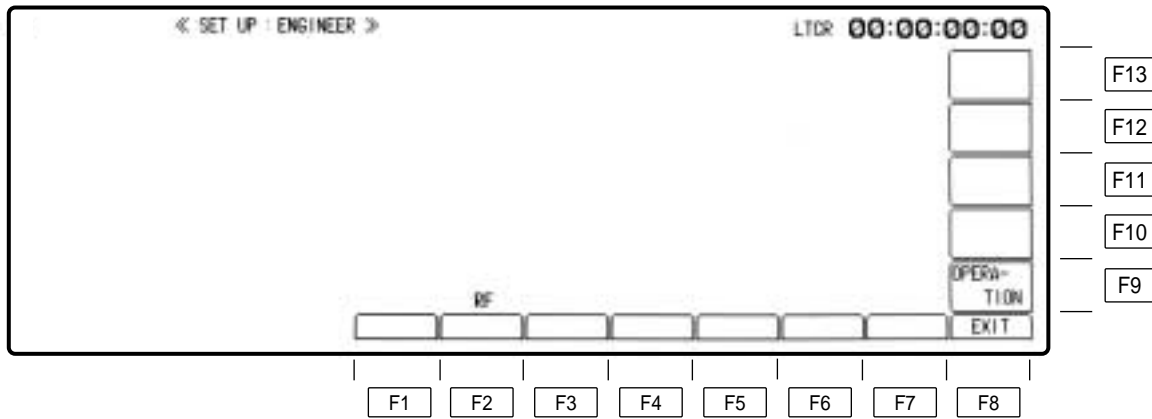

| Key | Key designation | Description |
|---------|-----------------|---|
| F1 | — | |
| F2 | RF | Transfers the VTR to the RF ENGINEER SET UP menu screen. |
| F3–F7 | — | |
| F8 | EXIT | Returns the VTR to the SET UP menu screen. |
| F9 | OPERATION | Transfers the VTR to the OPERATION ENGINEER SET UP menu screen. |
| F10–F13 | — | |

RF ENGINEER SET UP menu

This menu is displayed when the [SET UP] → [F13] and [F] keys are pressed together and then the [F13] key followed by the [F2] key are pressed.

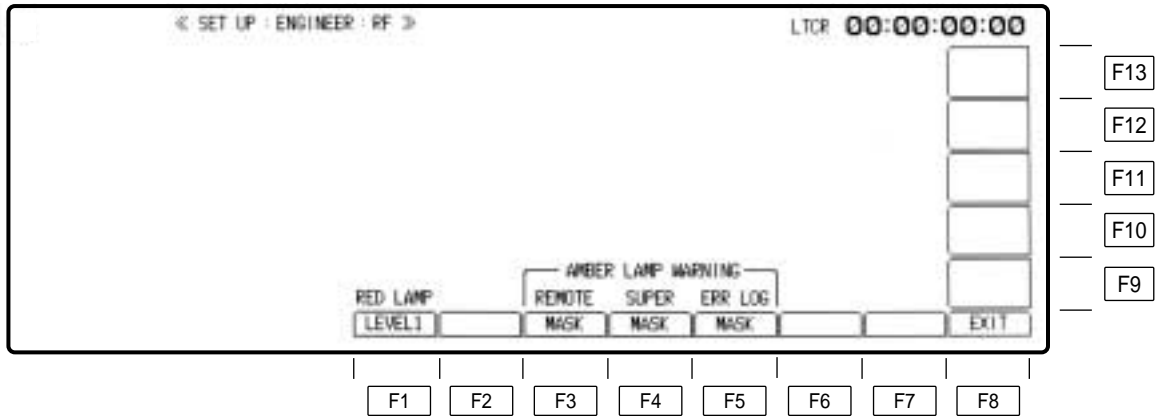

RF ENGINEER SET UP menu

The Conceal V warning sensitivity and warning display output are set on this menu.

| Key | Key designation | Description |
|--------|-----------------|---|
| F1 | RED LAMP | For selecting the lighting specifications for the red lamp on the front panel. When this lamp is lighted, the superimposed warning display, error log recording and remote output connectors (RS-232C/RS-422/PARALLEL) are also linked. LEVEL0: . . . (Setting for enhanced detection sensitivity: The red lamp lights even when one error occurs.) LEVEL1: . . . (Standard factory setting) LEVEL2: . . . (Setting with slightly reduced detection sensitivity) LEVEL3: . . . (Setting with further reduced detection sensitivity) |
| F2 | — | |
| F3 | REMOTE | For selecting whether to output or mask the warning amber information (CONCEAL_A, CONCEAL_V, HIGH_ERROR_RATE) of the RS-232C, RS-422 and PARALLEL output connectors. When the red lamp is lighted, the information is output regardless of which setting has been selected for this item. ACTIVE: When the amber warning lamp on the front panel is lighted, the information is also output to the external remote. MASK: Even when the amber warning lamp on the front panel is lighted, the information is not output to the external remote. |
| F4 | SUPER | For selecting whether to output or mask the superimposed warning amber information (CONCEAL_A, CONCEAL_V, HIGH_ERROR_RATE). When the red lamp is lighted, the information is output regardless of which setting has been selected for this item. ACTIVE: When the amber warning lamp on the front panel is lighted, the superimposed information is displayed. MASK: Even when the amber warning lamp on the front panel is lighted, the superimposed information is not displayed. |
| F5 | ERR LOG | For selecting whether to record the warning amber information (CONCEAL_A, CONCEAL_V, HIGH_ERROR_RATE) in the error log or mask it. When the red lamp is lighted, the information is recorded in the error log regardless of which setting has been selected for this item. ACTIVE: When the amber warning lamp on the front panel is lighted, the information is stored in the error log. MASK: Even when the amber warning lamp on the front panel is lighted, the information is not stored in the error log. |
| F6-F7 | — | |
| F8 | EXIT | For returning operation to the ENGINEER SET UP menu. |
| F9-F13 | — | |

The underlining indicates the factory setting.

OPERATION ENGINEER SET UP menu

This menu is displayed when the [SET UP] → [F13] and [F] keys are pressed together and then the [F9] key is pressed.

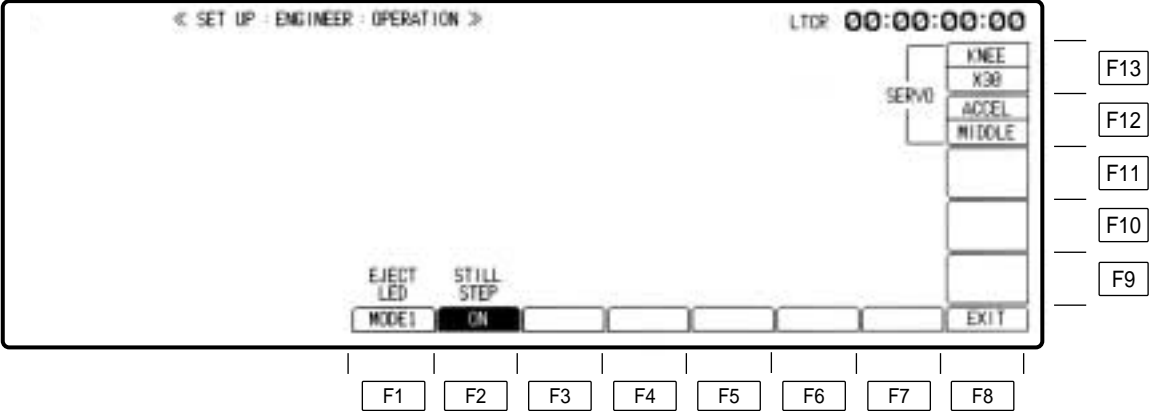

OPERATION ENGINEER SET UP menu

| Key | Key designation | Description |
|--------|-----------------|--|
| F1 | EJECT LED | <p>Enables the lighting conditions of the EJECT button's LED to be selected.</p> <p>MODE 1: The LED lights during the time starting when the VTR is transferred to the eject mode until the cassette is ejected or when cassette unloading is completed. (It lights during the unloading period and in the EJECT mode.)</p> <p>MODE 2: The LED lights during the time starting when the VTR is transferred to the eject mode until the cassette is ejected. (It lights only during the unloading period.)</p> |
| F2 | STILL STEP | <p>ON: When the stop/still mode holding time is set to 5 min with the F12 (STILL) key of the HOME SET UP menu and then this F2 key to ON, still time can be extended to 30 minutes moving the tape back and forth slightly. The tape is moved one frame amount every 2 minutes elapsed, and the tape movement is stopping within about ± 2 frames from the beginning point of this mode. The VTR is transferred to the tape tension release (loosing) mode in order to prevent the tape damage after 30 minutes has elapsed. Note that the CUE audio is output while the STILL STEP mode is activated. This function does not work other than 5 min in the F12 (STILL) key setting of the HOME SET UP menu.</p> <p>OFF: STILL STEP does not function. When the stop/still mode holding time has elapsed, the VTR is transferred to the tape tension release (loosing) mode.</p> |
| F3–F7 | — | |
| F8 | EXIT | Returns the VTR to the ENGINEER SET UP menu screen. |
| F9–F11 | — | |
| F12 | ACCEL | <p>Selects how far to accelerate the reel at a speed under multiple speed selected by F13 (KNEE) during a FF or REW operation (in the SHTL mode).</p> <p>MAX: Maximum acceleration is applied at all times.</p> <p>MIDDLE: Medium acceleration as far as the knee is applied. (This is the default value.)</p> <p>MIN: The acceleration as far as the knee is reduced.</p> <ul style="list-style-type: none"> ●When the MAX setting is selected, there is no knee due to the maximum acceleration. ●There is no knee when an L-size cassette is used. |
| F13 | KNEE | <p>Selects the multiple of the normal speed at which the reel speed is to be transferred from the acceleration selected by F12 (ACCEL) to maximum acceleration during a FF or REW operation (in the SHTL mode).</p> <p>×8: 8×normal speed ×15: 15×normal speed ×20: 20×normal speed ×30: 30×normal speed</p> |

TEST menu

This menu is displayed when the **TEST** key is pressed.

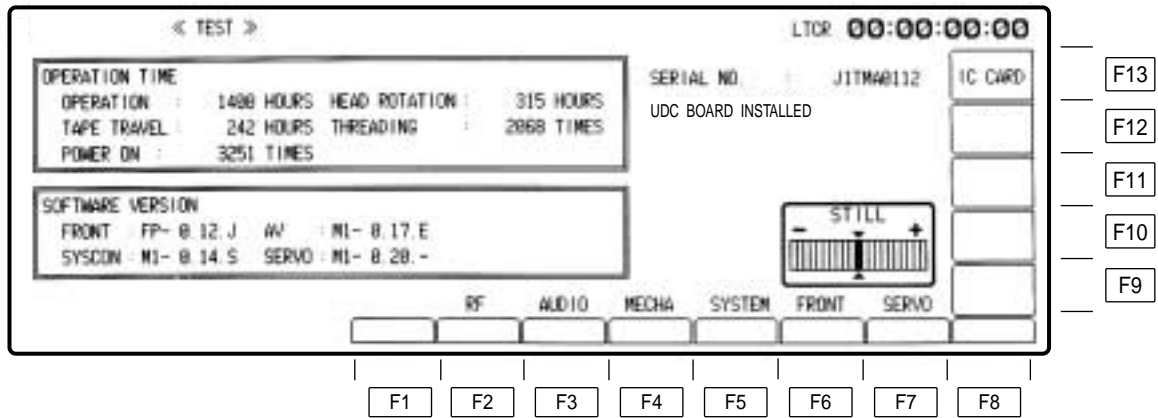

| Key | Key designation | Description |
|--------|-----------------|--|
| F1 | — | |
| F2 | RF | Transfers the VTR to the RF TEST menu screen. |
| F3 | AUDIO | Transfers the VTR to the AUDIO TEST menu screen. |
| F4 | MECHA | Transfers the VTR to the MECHA TEST menu screen. |
| F5 | SYSTEM | Transfers the VTR to the SYSTEM TEST menu screen. |
| F6 | FRONT | Transfers the VTR to the TEST FRONT menu screen. |
| F7 | SERVO | Transfers the VTR to the SERVO TEST menu screen. |
| F8–F12 | — | |
| F13 | IC CARD | Transfers the VTR to the TEST IC CARD menu screen. |

TEST menu

OPERATION TIME display

How long the VTR has been used for appears on this display.

OPERATION: Total power-on time
HEAD ROTATION: Cumulative head drum rotation time
TAPE TRAVEL: Cumulative tape travel time
THREADING: Total number of loading/unloading repetitions
POWER ON: Number of times power has been turned on

| | | | | | |
|----------------|---|------------|-----------------|-----------|------------|
| OPERATION TIME | | | | | |
| OPERATION | : | 1515 HOURS | HEAD ROTATION : | 370 HOURS | |
| TAPE TRAVEL | : | 225 HOURS | THREADING | : | 3870 TIMES |
| POWER ON | : | 9043 TIMES | | | |

SOFTWARE VERSION

The software versions appear on this display.

FRONT: Front software
SYSCON: System control software
AV: AV control software
SERVO: Servo software

| | | | | | |
|------------------|---|-----------|-------|---|-----------|
| SOFTWARE VERSION | | | | | |
| FRONT | : | FP-0.04.F | AV | : | M1-0.13.0 |
| SYSCON | : | M1-0.13.M | SERVO | : | M1-0.13.- |

Serial number display

The VTR's serial number appears here.

SERIAL NO:

UDC board display

The UDC board installed in the VTR appears here.

UDC BOARD INSTALLED

RF TEST menu

This menu is displayed by pressing the following keys: **TEST** → **F2**

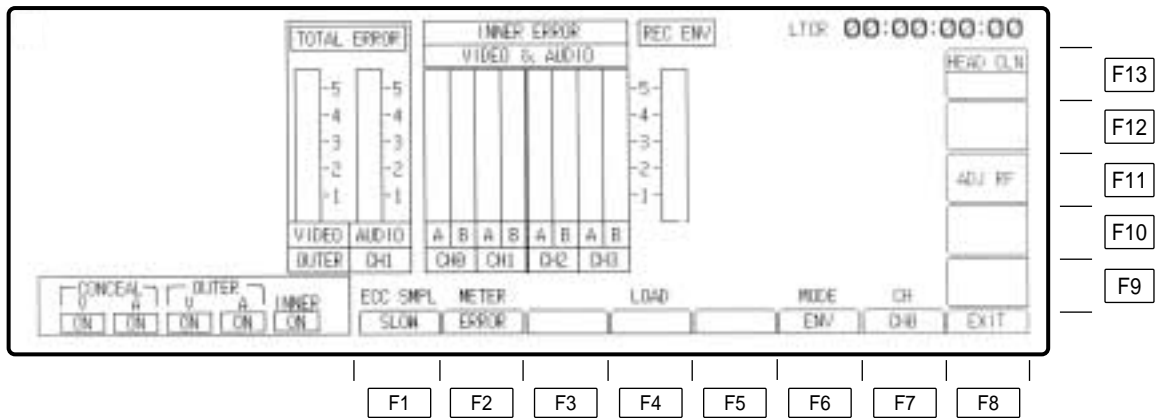

RF TEST menu

| Key | Key designation | Description |
|--------|---|---|
| F1 | EECC SMPL Change of error rate measurement time. | FAST: Measurement interval is 20 fields. SLOW: Measurement interval is 2 seconds. |
| F2 | METER Switch of meter display. | ERROR: Displays inner error level. ENV: Displays envelop level. |
| F3 | — | |
| F4 | LOAD Load of default value. | All RF adjustment values return to factory settings. (Executes when pressed together with F key.) |
| F5 | — | |
| F6 | MODE | For selecting waveform monitor (WFM) output.* EYE: Outputs eye pattern. ENV: Outputs envelop. CONFI: Outputs CONFI CTL. R/P: Outputs R/P CTL. TC: Outputs TC waveform. |
| F7 | CH | For selecting EYE/ENV channel.* CH0: Selects EYE or ENV of CH0. CH1: Selects EYE or ENV of CH1. CH2: Selects EYE or ENV of CH2. CH3: Selects EYE or ENV of CH3 |
| F8 | EXIT | Returns the VTR to the TEST menu screen. |
| F9–F10 | — | |
| F11 | ADJ RF RF adjustment value display. | RF adjustment value is displayed and F6, F7, F11 and F12 functions change to RF adjustment value display mode. Refer to “RF adjustment value display menu” (page 156). |
| F12 | — | |
| F13 | HEAD CLN Manual head cleaning. | While this key is pressed, head cleaning takes place. (Head cleaning lasts for a maximum of only 20 seconds.) Operation 1. Set VTR to PLAY mode. 2. Press the F13 (HEAD CLN) key. Head cleaning functions during PLAY, JOG or VAR mode. |

*When the RF adjustment value display mode has been entered by F11, the WFM selection made immediately beforehand is held.

RF TEST menu

□ Error rate display

The error rates (error occurrence rates) are indicated on the 1) TOTAL ERROR and 2) INNER ERROR displays.

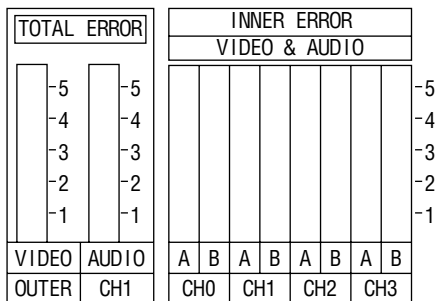

1) TOTAL ERROR

During recording, the error rate of the simultaneous playback signals is displayed. During playback, the error rate of the playback signals is displayed. The audio channels are switched using the center cursor key.

2) INNER ERROR

The error rates after the inner errors have been corrected are displayed for the 8 heads.

Proceed as follows to switch between VIDEO & AUDIO and AUDIO.

1. Press the center cursor key to display the cursor.
2. Press the F key and cursor key (◀ or ▶) together to move the cursor to INNER ERROR.
3. Press the center cursor key to select VIDEO & AUDIO or AUDIO.
4. Press the ENT key to enter the selection.

□ Correction and revision statuses



- Press the F key and cursor key together to move the highlighted portion from the error rate display described above.
- By aligning the cursor with CONCEAL V or A, with OUTER V or A, or with INNER and then pressing the center cursor key, it is possible to switch between ON and OFF.
- These settings are forcibly set to ON when the test menu is exited. Do NOT turn them OFF since doing so will cause noise to be generated in the playback picture and sound.

RF adjustment value display menu

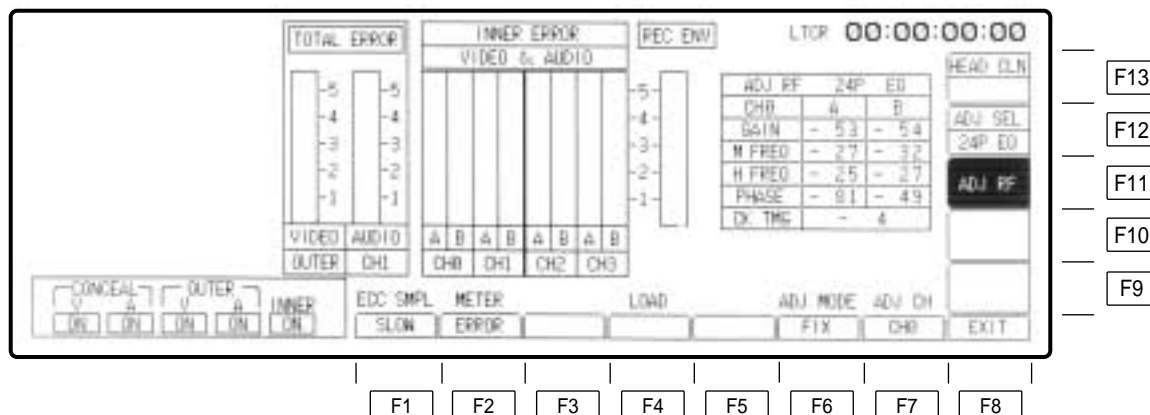

| Key | Key designation | Description |
|--------|--|---|
| F1–F5 | — | |
| F6 | ADJ MODE Adjust mode. | FIX: Holds the current adjusted value. Parameter can be readjusted by remote adjustment but the value cannot be changed with this unit. |
| F7 | ADJ CH | Selects the channel for display. EQ/REC/PLL: CH0, CH1, CH2, CH3 |
| F8–F10 | — | |
| F11 | ADJ RF RF adjustment value display. | When the F11 key is pressed, ADJ SEL is displayed at the F12 key and the current adjusted value of the selected parameter is displayed. Selects adjustment mode with F6 key and channel with F7 key. |
| F12 | ADJ SEL | This is used to display the selected RF adjusted value. EQ: The adjusted value of the playback equalizer is displayed. REC: The recording adjusted value is displayed. PLL: The PLL relative speed adjusted value is displayed. Pressing the F12 key enables switching by a toggling action in the following sequence: ***EQ→***PLL→***REC→***EQ→ and so on. Pressing the F key and F12 key together enables switching by a toggling action in the following sequence: 6014**→6018**→501**→24P**→625**→D3**→6014** and so on. The RF system adjusted values for each format are displayed as these adjusted values. (They are used by the servicing engineer.) |

AUDIO TEST menu

This menu is displayed by pressing the following keys: **TEST** → **F3**

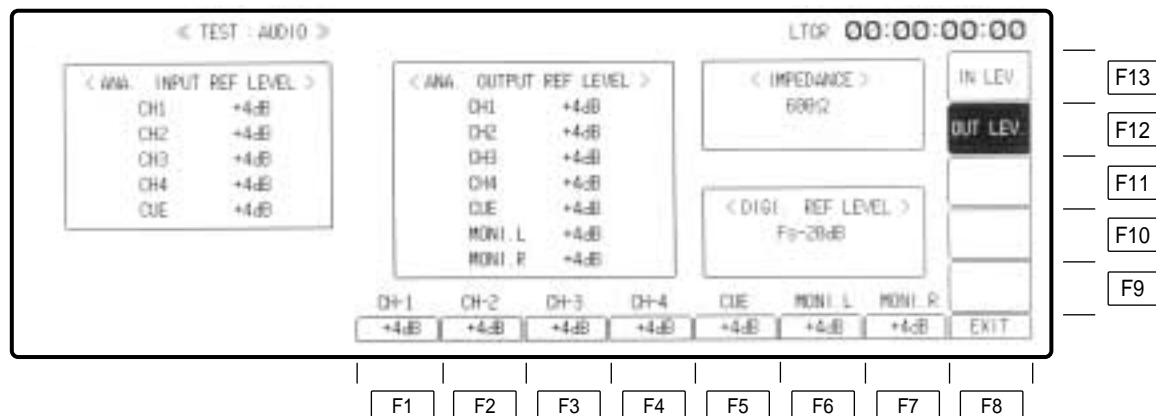

| Key | Key designation | Description |
|-----|-----------------|---|
| F1 | CH-1 | Sets the CH1 analog input/output reference level. |
| F2 | CH-2 | Sets the CH2 analog input/output reference level. |
| F3 | CH-3 | Sets the CH3 analog input/output reference level. |
| F4 | CH-4 | Sets the CH4 analog input/output reference level. |
| F5 | CUE | Sets the CUE input/output reference level. |
| F6 | MONI.L | Sets the monitor L channel output reference level. |
| F7 | MONI.R | Sets the monitor R channel output reference level. |
| F8 | EXIT | Returns the VTR to the TEST menu screen. |
| F9 | REF.LEV | Sets the PCM audio reference level. (This can be done only in the servicing engineer mode.) <ul style="list-style-type: none"> When the F9 and F keys are pressed together, the reference level (Fs) toggles between -18 dB and -20 dB. |
| F10 | IMPED. | Sets the input impedance. (This can be done only in the servicing engineer mode.) <ul style="list-style-type: none"> When the F10 and F keys are pressed together, the input impedance is toggled between 600 ohms and HIGH. |
| F11 | — | |
| F12 | OUT LEV. | Sets the analog output reference level. <ul style="list-style-type: none"> When the F12, BS and F keys are pressed together, the names of the F1 to F7 menus are displayed, and switching between them is acknowledged. |
| F13 | IN LEV. | Sets the analog input reference level. <ul style="list-style-type: none"> When the F12, BS and F keys are pressed together, the names of the F1 to F5 menus are displayed, and switching between them is acknowledged. |

MECHA TEST menu

This menu is displayed by pressing the following keys: **TEST** → **F4**

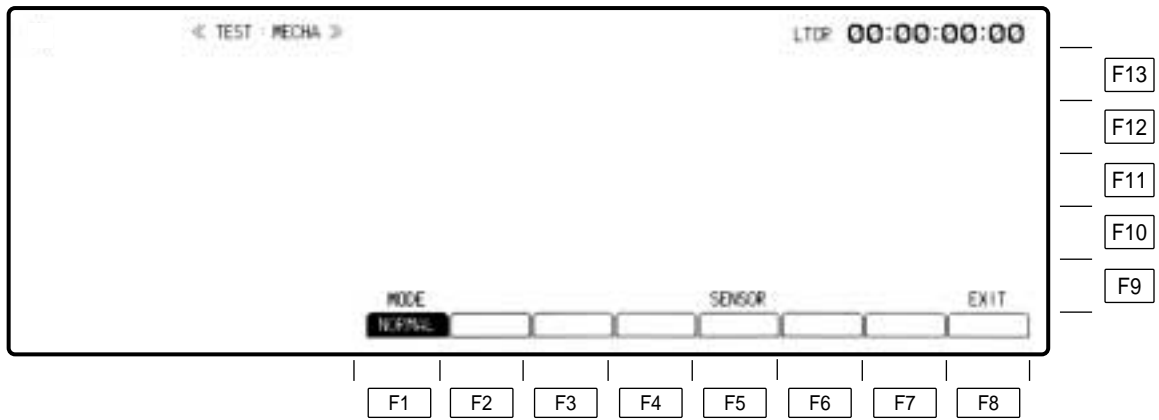

The menu below is displayed when the **F5** key is pressed.

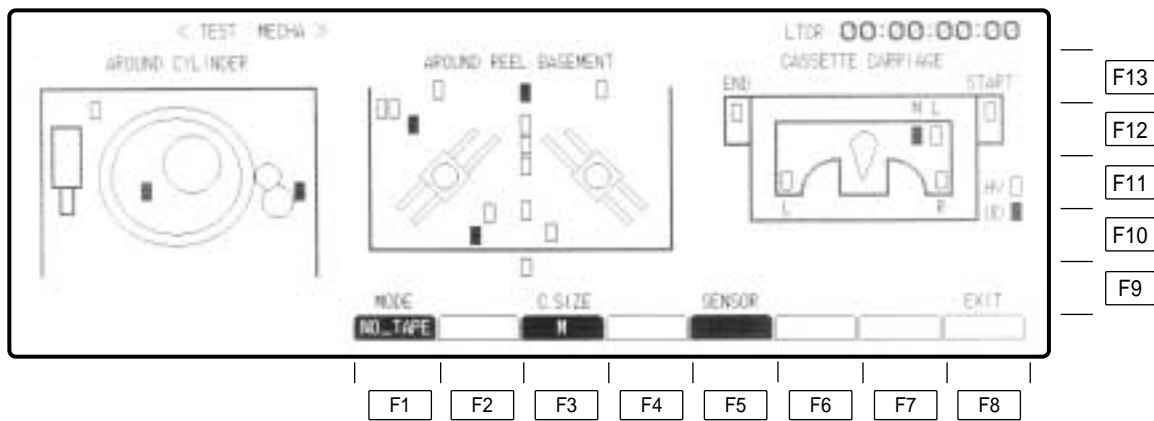

MECHA TEST men

| Key | Key designation | Description |
|--------|------------------------------------|--|
| F1 | MODE Loading without tape. | NORMAL: Normal operation. NO-TAPE: Loading without cassette tape is possible. Loading starts when the STOP button is pressed. Cassette is selected with F3 key. To abort operation, press the EJECT button. |
| F2 | — | |
| F3 | C.SIZE Cassette size selection. | Selects the size of the pseudo cassette when [NO TAPE] has been selected with F1 key. Large, medium or small cassette size can be selected. |
| F4 | — | |
| F5 | SENSOR Sensor operation check. | When this key is pressed for highlighting, the sensor frame is shown on the menu. Operation of each peripheral sensor of cylinder, reel base and front loading is checked. This key is especially for checks by service personnel. Press the F8 (EXIT) key to restore the original frame. |
| F6–F7 | — | |
| F8 | EXIT | Returns the VTR to the TEST menu screen. |
| F9–F13 | — | |

SYSTEM TEST menu

This menu is displayed by pressing the following keys: **TEST** → **F5**.

This menu contains keys for adjustments by service personnel. General users cannot operate these keys. Press F8 key to return to TEST menu.



| Key | Key designation | Description |
|--------|-----------------|--|
| F1-F7 | — | |
| F8 | EXIT | Returns the VTR to the TEST menu screen. |
| F9-F13 | — | |

SERVO TEST menu

This menu is displayed by pressing the following keys: **TEST** → **F7**.

The screenshot shows the SERVO TEST menu with various data fields and function key callouts (F1-F13). The menu is organized into several sections:

- REEL TORQUE:**

| | |
|------------|------|
| LOADING | +122 |
| T-REEL FND | +112 |
| LOOSING | +128 |
- AT:**

| | | |
|-------------|------|------|
| | A CH | B CH |
| NATURAL POS | - 65 | - 59 |
| STRN DC DS | + 26 | + 4 |
| STRN GAIN | +181 | + 67 |
| RESONANCE | + 65 | + 98 |
| DRIVE GAIN | +118 | +118 |
| GROUP DELAY | +111 | +183 |
- TOTAL ERROR:** Two vertical bar graphs for VIDEO and AUDIO channels, ranging from -5 to 0.
- INNER ERROR VIDEO & AUDIO:** A grid of 12 vertical bar graphs for channels A and B across three data sources (CH0, CH1, CH2, CH3).
- REC ENV:** A vertical bar graph ranging from -5 to 0.
- TRACKING:** A horizontal bar graph with a slider set to 'B'.
- MECHA:**
 - SR: ~~DISCON~~ LINEAR
 - TC DELAY: ~~BRDR~~ OFF
- STATUS BAR:**

| | | | | | | | |
|--------|-----------|---------|----|-------|----------|----------|-------|
| TORQUE | DATA SEND | MEASURE | AT | METER | PG SHIFT | ADJ RATE | MECHA |
| | | OFF | | ERROR | +1892 | FINE | EXIT |
- RIGHT SIDE CALLOUTS:**
 - F13: ADJ ENABLE
 - F12: BIMORPH INIT
 - F11: X VALUE + 69
 - F10: TRACKING OPT ONCE
 - F9: MECHA
- BOTTOM CALLOUTS:**
 - F1: TORQUE
 - F2: DATA SEND
 - F3: MEASURE
 - F4: AT
 - F5: METER
 - F6: PG SHIFT
 - F7: ADJ RATE
 - F8: MECHA

SERVO TEST menu

| Key | Key designation | Description |
|-----|--|---|
| F1 | TORQUE Reel torque adjustment. | Key for adjustment by service personnel. |
| F2 | DATA SEND Torque data forwarding. | Key for adjustment by service personnel. |
| F3 | MEASURE (Measure) | Key for adjustment by service personnel. |
| F4 | AT AT head adjustment. | Key for adjustment by service personnel. |
| F5 | METER | ERROR: Displays inner error level. ENV: Displays envelop level. |
| F6 | PG SHIFT PG shifter adjustment. | Key for adjustment by service personnel. |
| F7 | ADJ RATE Adjust rate. | Key for adjustment by service personnel. |
| F8 | EXIT | Returns the VTR to the TEST menu screen. |
| F9 | MECHA Mechanical adjustment. | Key for adjustment by service personnel. |
| F10 | TRACKING Tracking adjustment. | Under normal conditions, tracking adjustment is not necessary. Adjust if there are tracking discrepancies while editing. VAR: Tracking is adjusted manually. Refer to “Manually adjusting the tracking” (page 106). FIX: Tracking is fixed at the center position of the manual adjustment. OPT. ONCE: Tracking is optimized only once while the tape is playing up to the IN point during the first editing after the cassette has been inserted. Thereafter, optimization does not take place. However, optimization can be performed again. Refer to “Automatically adjusting the tracking” (page 100). OPT. AUTO: Tracking is optimized while the tape is playing up to the IN point with each editing. Refer to “Automatically adjusting the tracking” (page 105). |
| F11 | X VALUE | Key for X value adjustment by service personnel. |
| F12 | BIMORPH INIT Removal of hysteresis at AT voltage element. | Key for adjustment by service personnel. |
| F13 | ADJ ENABLE | Key for adjustment by service personnel. |

SERVO TEST menu

Error rate display

The error rates are displayed in terms of the 1) TOTAL ERROR and 2) INNER ERROR.

For details, refer to the description of the error rate display for the RF TEST menu (on page 155).

Tracking adjustment

For details of the tracking adjustment, refer to the INSERT/ASSEMBLE MANUAL EDIT SET UP menu (on page 105).

TEST FRONT menu

This menu is displayed by pressing the following keys: **TEST** → **F6**

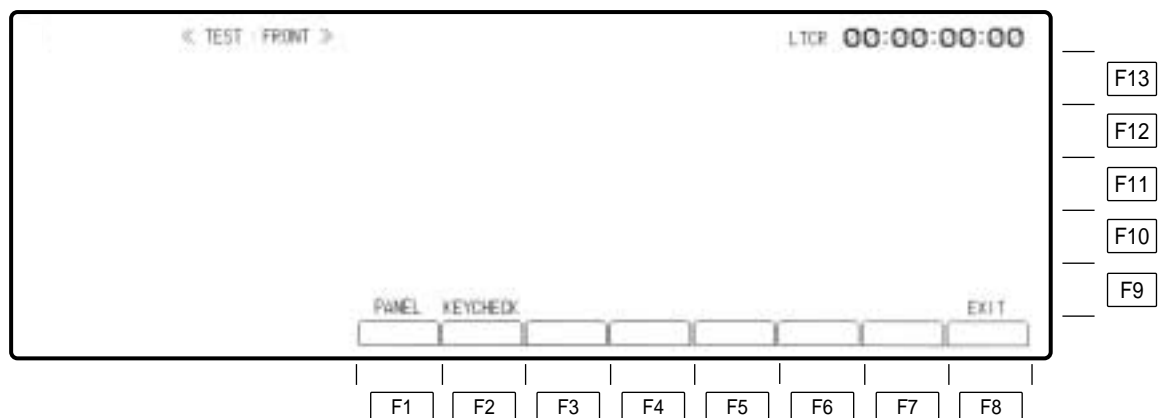

| Key | Key designation | Description |
|--------|------------------------------------|--|
| F1 | PANEL Display check. | Transfers the VTR to TEST FRONT PANEL menu screen. |
| F2 | KEYCHECK Front panel key check. | Transfers the VTR to the TEST KEY CHECK menu screen. |
| F3–F7 | — | |
| F8 | EXIT | Returns the VTR to the TEST menu screen. |
| F9–F13 | — | |

TEST FRONT PANEL menu

This menu is displayed by pressing the following keys: **TEST** → **F6** → **F1**.

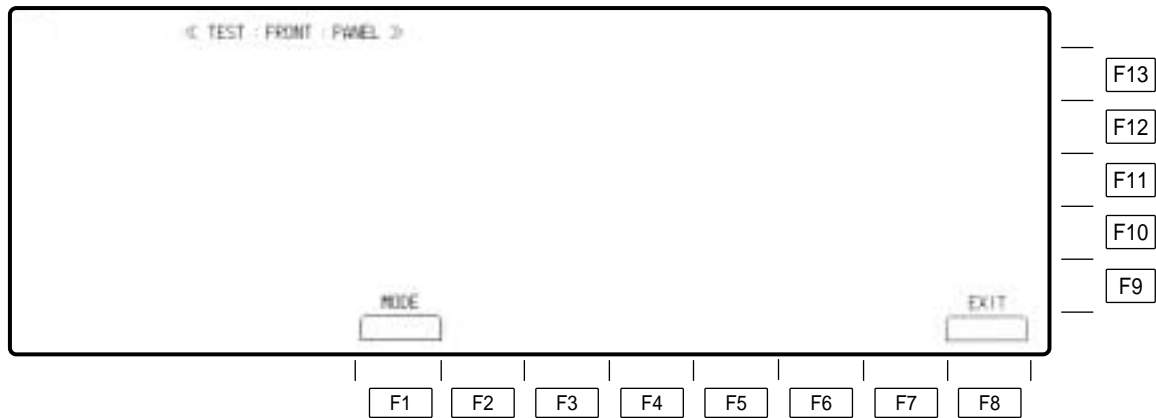

| Key | Key designation | Description |
|--------|----------------------------|--|
| F1 | MODE Display dot check. | The entire display panel is lighted up in a fixed pattern and display dots are checked. Each time the key is pressed, 12 types of pattern are displayed. |
| F2-F7 | — | |
| F8 | EXIT | Returns the VTR to the TEST FRONT menu screen. |
| F9-F13 | — | |

TEST FRONT KEY CHECK IN menu

This menu is displayed by pressing the following keys: **TEST** → **F6** → **F2**.

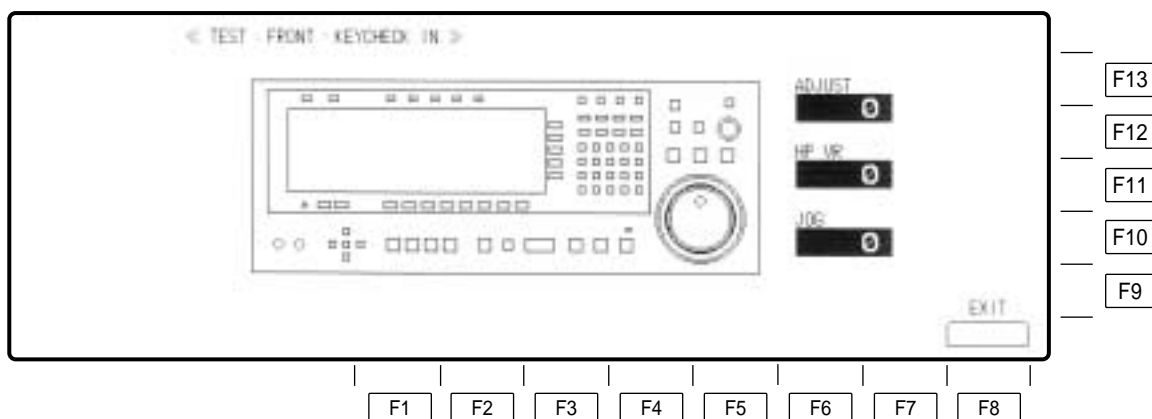

| Key | Key designation | Description |
|--------|-----------------|--|
| F1-F7 | — | |
| F8 | EXIT | Returns the VTR to the TEST FRONT menu screen. |
| F9-F13 | — | |

TEST FRONT KEY CHECK IN menu

Dial and controls

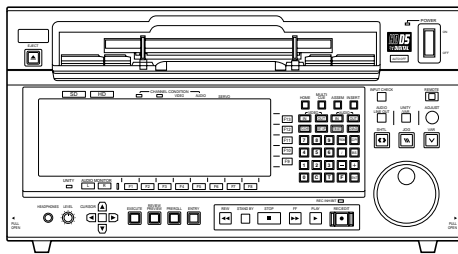

When the ADJUST control, headphones control or search dial is turned, the number of pulses counted is displayed.

LEDs

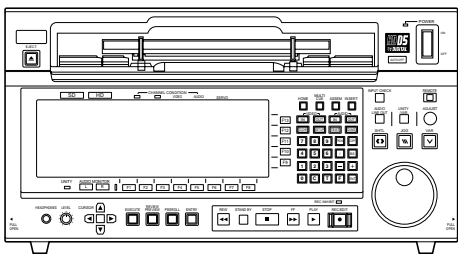

Each time the F1 key is pressed, the LEDs on the panel light up in sequence and are checked.

Keys

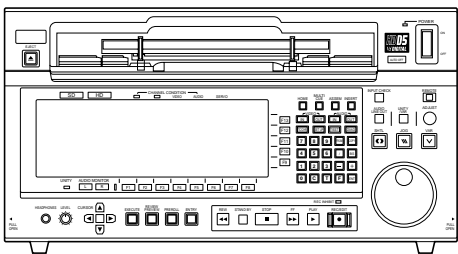

When a key (button) on the panel is pressed, the corresponding key on the menu screen is highlighted, and the buzzer sounds at the same time. This makes it possible to confirm that the front microcomputer has recognized the key.

Inserting the IC card

The insertion slot for the IC card is located on the back left of the front panel. Insert the IC card before using the TEST IC CARD menu.

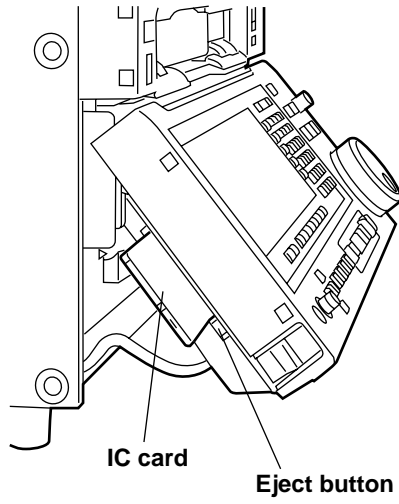

TEST IC CARD menu

Preparations

When an error to be logged has occurred, this unit enables information on the date and time of the occurrence of the error to be recorded in addition to the TC information in the log. Initial registration of the date and time is required in order for this information to be recorded. Bear in mind that if the unit's power has been off for more than one week, it will be necessary to re-register the date and time.

How to register the date and time

When **TEST** and then the **F13** key are pressed, a menu appears.

1. Press the center cursor key.

The year display at the top center of the front panel now appears as a white-on-black display.

2. Use the number keys to change the date and time.

Use the cursor keys (**◀**, **▶**) to move the white-on-black display to the location where the information is to be changed, and change the information using the number keys.

3. After having changed and registered the date and time information, press the ENT key to enter it.

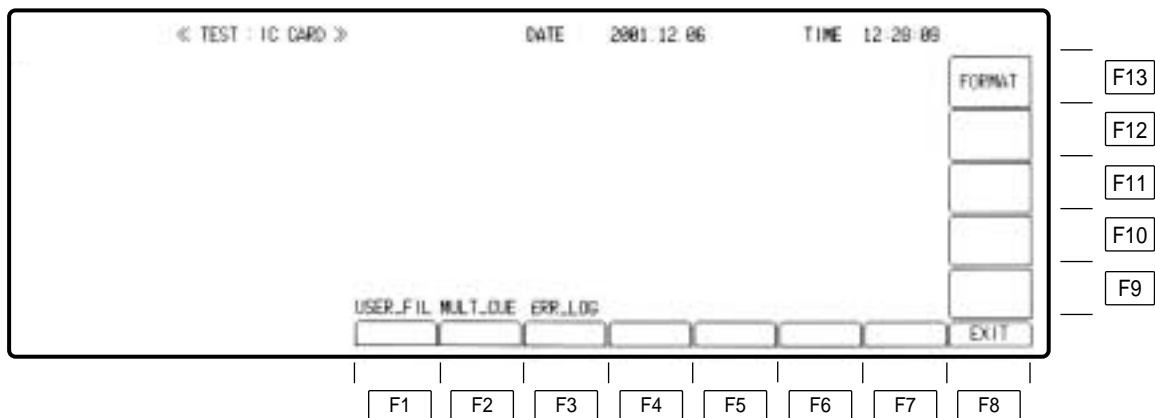

TEST IC CARD menu

| Key | Key designation | Description |
|--------|-----------------|--|
| F1 | USER_FIL | User file management takes place using IC card. When the F key is pressed, transfer is made to TEST IC CARD USER FILE menu. <ul style="list-style-type: none"> •There is a load/save function for current (present deck status) and all registered files. •When user file is forwarded to deck, whether SYS_H and SYS_C should be sent together can be selected. |
| F2 | MULT_CUE | 100 CUE_POINTS (MULTI_CUE) can be loaded/saved to IC card. When the F key is pressed, transfer is made to MULTICUE menu. <ul style="list-style-type: none"> •Whether to send all at once or by page can be selected. |
| F3 | ERR_LOG | Function available for memory of deck mode, time code, type and date/time when warning appears. When the F3 key is pressed, the VTR is transferred to the TEST IC CARD ERROR LOG menu. <ul style="list-style-type: none"> •Function available for 50-step memory data. •When memory buffer becomes full, there is a function for switching to erasure of old material and renewal of new warning. •Function available for memory storage of this data on IC card. •Function available to monitor IC card data. |
| F4–F7 | — | |
| F8 | EXIT | Returns the VTR to the TEST menu screen. |
| F9–F12 | — | |
| F13 | FORMAT | IC card is formatted. Please note that all data on the IC card is destroyed. When the F key is pressed together with C key and F13 (FORMAT) key, the IC card is formatted. |

<Note>

Avoid installing an IC card formatted by this unit in the AJ-HD2000, AJ-HD2700, AJ-HD3000, AJ-HD3700, AJ-HD3700H, AJ-HD3700A or any other model.

Conversely, avoid installing an IC card formatted by any other model in this unit.

The file structure used for these cards is different from one model to another, and this may give rise to problems in the VTR's operation.

TEST IC CARD USER menu

This menu is displayed by pressing the following keys: **TEST** → **F13** → **F1**.

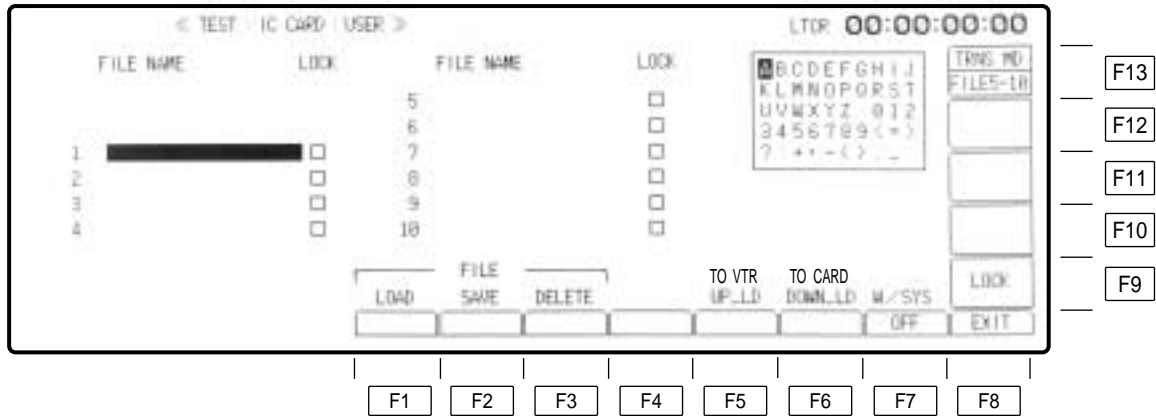

•User Files (TEST menu)

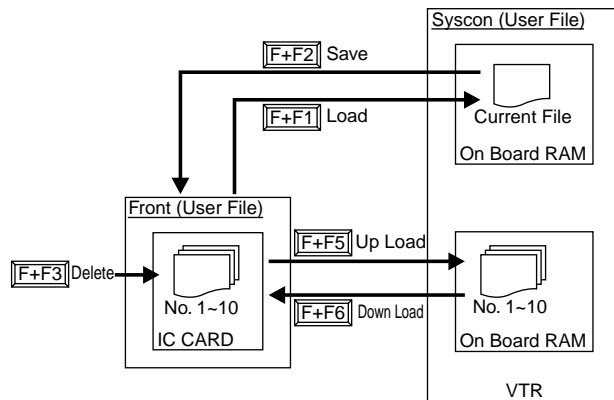

<TEST IC CARD: USER menu function settings>

| Key | Key designation | Description |
|-----|--------------------|--|
| F1 | LOAD | Press together with F key. This calls the IC card's user files. |
| F2 | SAVE | Press together with F key. This saves the user files on the IC card. |
| F3 | DELETE | Press together with F key. This deletes the IC card's user files. |
| F4 | — | |
| F5 | TO VTR UP_LD | Press together with F key. This uploads saved files from the IC card to the VTR. |
| F6 | TO CARD DOWN_LD | Press together with F key. This downloads saved files from the VTR to the IC card. |
| F7 | W/SYS | This selects whether or not to overwrite SYS_H and SYS_SC when transferring the user files from the IC card to the VTR. |
| F8 | EXIT | This returns the system to the TEST IC CARD menu. |
| F9 | LOCK | This is used to release the lock on and perform the settings for the user files. |
| F10 | — | |
| F11 | — | |
| F12 | — | |
| F13 | TRNS MD | This selects whether to upload FILE 5 to 10 or all files when uploading saved files from the IC card to the VTR. All files can be uploaded when F13 key is pressed while holding down the F key. |

TEST IC CARD MULTI CUE menu

This menu is displayed by pressing the following keys: **TEST** → **F13** → **F2**

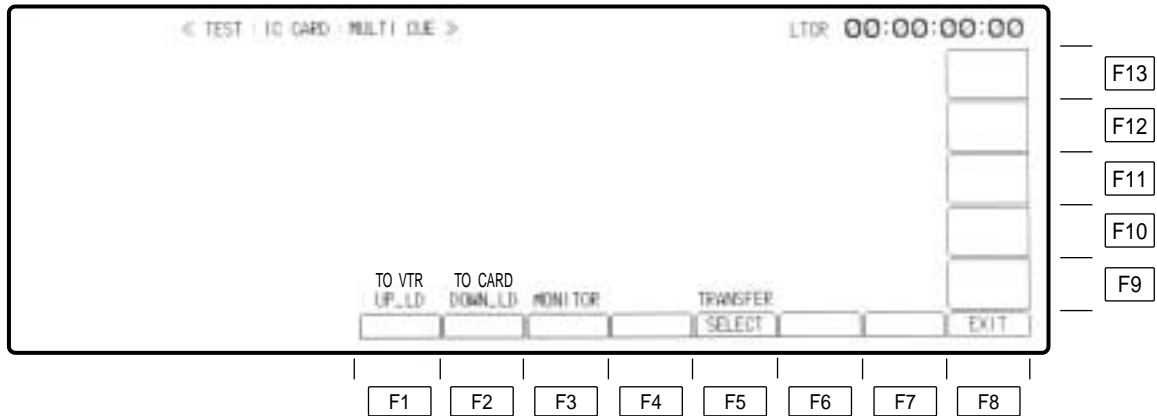

•Multi Cue Files (TEST menu)

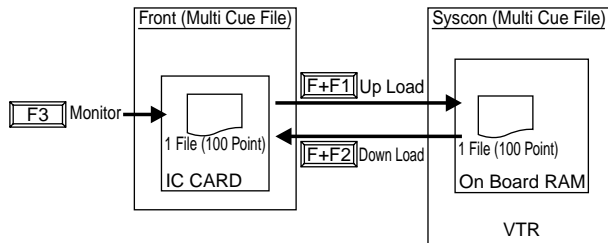

<TEST IC CARD: MULTI CUE menu function settings>

| Key | Key designation | Description |
|--------|--------------------|--|
| F1 | TO VTR UP_LD | Press together with F key. This uploads saved files from the IC card to the VTR. |
| F2 | TO CARD DOWN_LD | Press together with F key. This downloads saved files from the VTR to the IC card. |
| F3 | MONITOR | This displays the MULTI_CUE data saved on the IC card. |
| F4 | — | |
| F5 | TRANSFER | This selects whether to transfer all data at once or by page when uploading from the IC card to the VTR. |
| F6 | — | |
| F7 | — | |
| F8 | EXIT | This returns the system to the TEST IC CARD menu. |
| F9-F13 | — | |

TEST IC CARD MULTI CUE SELECT menu

This menu is displayed when the **TEST** → **F13** → **F2** → **F** and **F1** keys are pressed together.

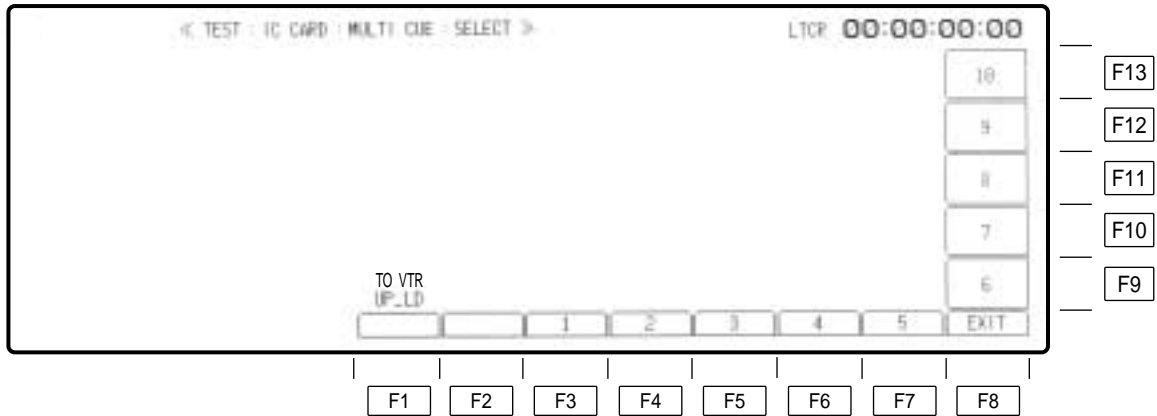

<TEST IC CARD: MULTI CUE: SELECT menu function settings>

| Key | Key designation | Description |
|--------|-----------------|--|
| F1 | TO VTR UP_LD | Press together with F key. This uploads the selected files from the IC card to the VTR. |
| F2 | — | |
| F3–F7 | 1–5 | This selects the page to be transferred. |
| F8 | EXIT | This returns the system to the TEST IC CARD: MULTI CUE menu. |
| F9–F13 | 6–10 | This selects the page to be transferred. |

TEST IC CARD MULTI CUE MONITOR menu

This menu is displayed by pressing the following keys: **TEST** → **F13** → **F2** → **F3**.

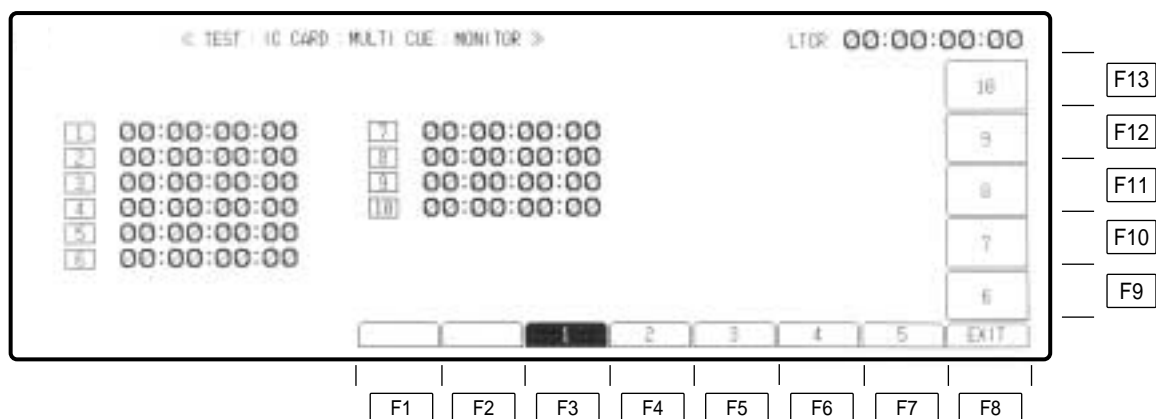

| Key | Key designation | Description |
|--------|---|--|
| F1–F2 | — | |
| F3–F7 | 1–5 Designation of 1–5 cue number. | |
| F8 | EXIT | Returns the VTR to the TEST IC CARD MULTI CUE menu screen. |
| F9–F13 | 6–10 Designation of 6–10 cue number. | |

TEST IC CARD ERROR LOG menu

This menu is displayed by pressing the following keys: **TEST** → **F13** → **F3**

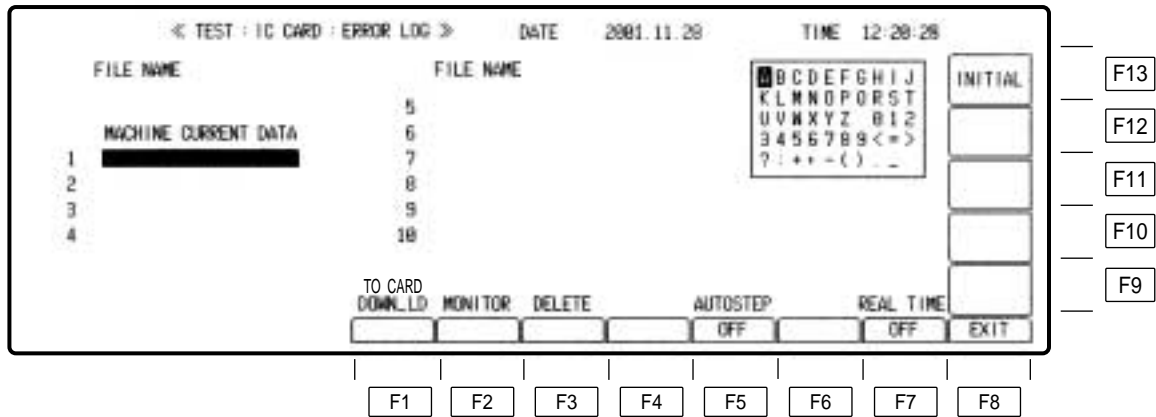

• Error Log Files

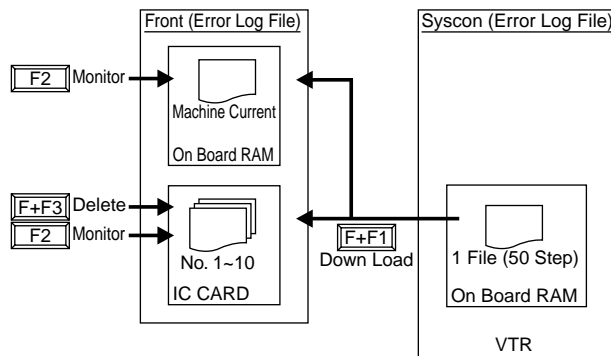

<TEST IC CARD: ERROR LOG menu function settings>

| Key | Key designation | Description |
|-----|--------------------|--|
| F1 | TO CARD DOWN_LD | Press together with F key. This uploads saved files from the VTR to the IC card. "TO FRONT" is displayed when MACHINE CURRENT DATA has been selected. When the file upload has been completed, the system automatically transfers to the MONITOR menu. |
| F2 | MONITOR | This displays the ERROR_LOG data saved in the memory. |
| F3 | DELETE | Press together with F key. This erases the ERROR_LOG data saved on the IC card. |
| F4 | — | |
| F5 | AUTOSTEP | This selects whether to delete items in order from the oldest and update the log or not when the number of warnings has exceeded the buffer capacity. |
| F6 | — | |
| F7 | REAL TIME | This selects whether or not to display REAL TIME with the MONITOR menu. |
| F8 | EXIT | This returns the system to the TEST IC CARD menu. |
| F9 | — | |
| F10 | — | |
| F11 | — | |
| F12 | — | |
| F13 | INITIAL | When F13 key is pressed while holding down the F key, all ERROR LOG data currently stored in the VTR's memory are erased. |

TEST IC CARD ERROR LOG MONITOR menu

This menu is displayed by pressing the following keys: **TEST** → **F13** → **F3** → **F2** keys are pressed.
 To check the current log data of the VTR, first download the machine current data, and then monitor the log data.

| NO | WARNING | MODE | OFF TAPE TIME CODE | DATE | TIME |
|----|----------------------|-------------|--------------------|----------|----------|
| 41 | CONCEAL A | NORMAL PLAY | 00:00:24:00 | 01.12.05 | 16:38:37 |
| 42 | CONCEAL A | NORMAL PLAY | 00:00:32:00 | 01.12.05 | 16:38:45 |
| 43 | CONCEAL A | NORMAL PLAY | 00:00:52:00 | 01.12.05 | 16:39:05 |
| 44 | INNER ECC SW OFF | NORMAL PLAY | 00:00:56:00 | 01.12.05 | 16:39:09 |
| 45 | CONCEAL A | NORMAL PLAY | 00:01:02:00 | 01.12.05 | 16:39:15 |
| 46 | LTC IN TAPE NOT READ | NORMAL PLAY | 00:00:01:00 | 01.12.05 | 11:58:07 |
| 47 | AUDIO MUTE | NORMAL PLAY | 00:00:05:11 | 01.12.06 | 11:58:11 |
| 48 | CONCEAL V | NORMAL PLAY | 00:00:05:11 | 01.12.06 | 11:58:11 |

TOTAL 6 / 7

EXIT

| Key | Key designation | Description |
|--------|-----------------|--|
| F1-F7 | — | |
| F8 | EXIT | Returns the VTR to the TEST IC CARD ERROR LOG menu screen. |
| F9-F13 | — | |

*When more errors are generated than the number that can be displayed on the front panel, use the scroll key to move the error display.

Error messages

Four kinds of error messages are displayed by this VTR.

(1) DIAG menu

A warning mark (W) blinks at the top left of the menu screen when an erroneous setting, failure to verify a condition, warning or other problem that interferes with the use of the VTR has arisen. When the DIAG key is pressed, an error message appears on the screen.

(2) AUTO OFF mode

When a problem occurs in the VTR and it is no longer possible to continue using the VTR without fixing it, the AUTO OFF lamp and SYSTEM lamp at the front of the VTR come on, and an error message appears on the display.

(3) System error

When a problem occurs in the VTR and its operation can no longer be guaranteed, the SYSTEM lamp at the front of the VTR comes on, and an error message appears on the display.

(4) Operation error

When the wrong button or key has been pressed or a wrong value has been input during operation, a message appears at the bottom right of the screen telling the user how to proceed with operation.

DIAG menu error messages

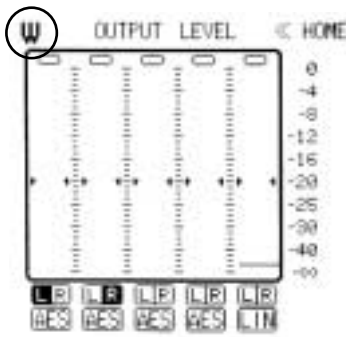

A warning mark (W) blinks at the top left of the screen when an erroneous setting, failure to verify a condition, warning or other problem that interferes with the use of the VTR has arisen.

If the DIAG key is pressed while a warning is shown, an error message appears on the screen.

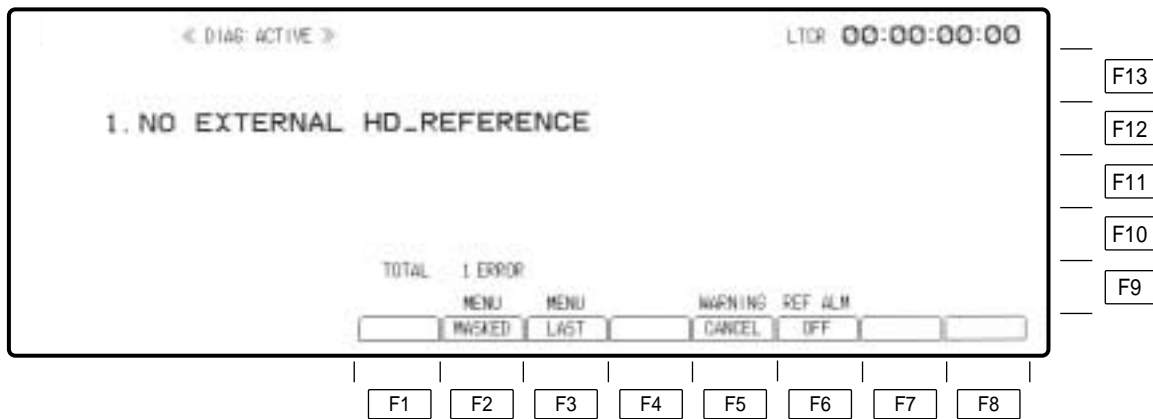

There are the following three kinds of DIAG menu screens.

- | | |
|------------------|---|
| DIAG ACTIVE menu | This is the menu that appears initially when the DIAG key is pressed. An error message corresponding to the unmasked (not canceled) warning which has just occurred is displayed. |
|------------------|---|

- | | |
|------------------|---|
| DIAG MASKED menu | This is the menu that appears when the F2 (MENU MASKED) key is pressed. An error message corresponding to the masked (canceled) warning is displayed. |
|------------------|---|

- | | |
|----------------|---|
| DIAG LAST menu | This is the menu that appears when the F3 (MENU LAST) key is pressed. The error messages for the last three warnings are displayed. |
|----------------|---|

*Any error message is cleared as soon as the error is remedied.

DIAG ACTIVE menu

When the DIAG key is pressed while the warning mark is displayed, the DIAG ACTIVE menu below appears.

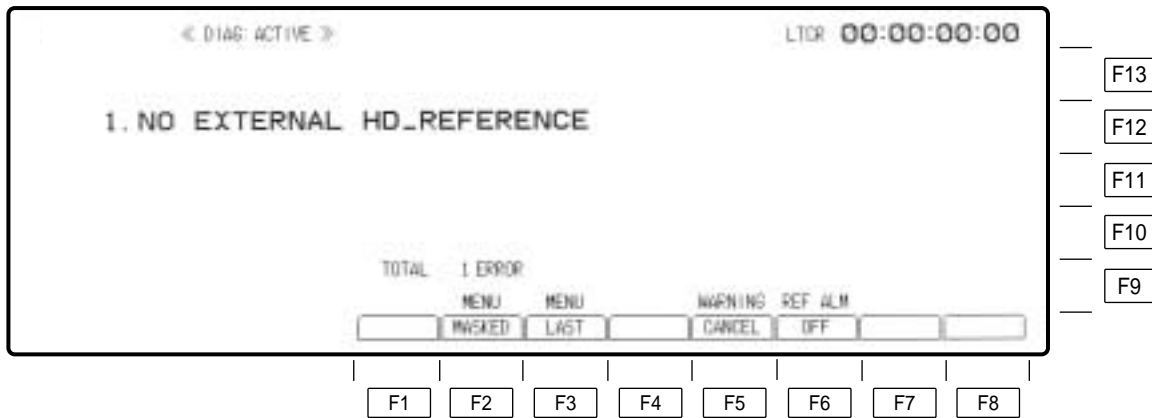

| Key | Key designation | Description |
|--------|-----------------|--|
| F1 | — | |
| F2 | MENU MASKED | Transfers the VTR to the DIAG MASKED menu screen. |
| F3 | MENU LAST | Transfers the VTR to the DIAG LAST menu screen. |
| F4 | — | |
| F5 | WARNING CANCEL | Masks (cancels) the warning currently on display in the DIAG ACTIVE menu. The error message for the masked warning can be displayed on the DIAG MASKED menu. |
| F6 | REF ALM | ON: When there is no REF input, STOP lamp blinks. OFF: When there is no REF input, STOP lamp does not blink. |
| F7-F13 | — | |

When there are multiple warnings

- Error messages are displayed from item of highest priority.
- All the messages can be viewed sequentially by operating the cursor and the up/down arrow keys.
- Total number of warnings is displayed.

When F6 (REF ALM) key is set to ON, refer to the following table.

| OUT_REF | SD_REF present/ absent | HD_REF present/ absent | STOP blinks/glows |
|------------|---------------------------|---------------------------|-------------------|
| AUTO/INPUT | Present | — | Glows* |
| | Absent | Present | Glows* |
| | | Absent | Blinks |
| HD | — | Present | Glows* |
| | | Absent | Blinks |
| SD | Present | — | Glows* |
| | Absent | | Blinks |

*This lamp lights in the STOP mode; it is off in all other modes.

DIAG MASKED menu

When the [F2] (MENU MASKED) key is pressed on the DIAG ACTIVE or DIAG LAST menu, the DIAG MASKED menu below appears.

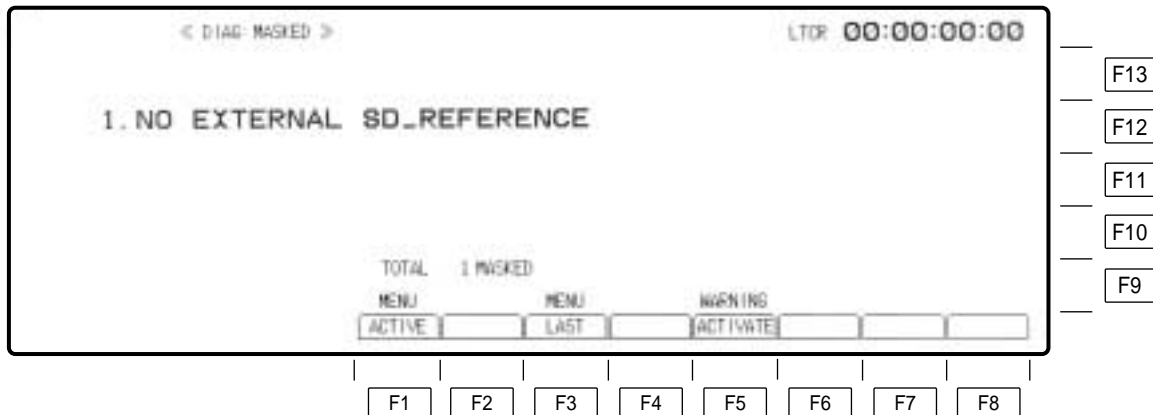

| Key | Key designation | Description |
|--------|------------------|---|
| F1 | MENU ACTIVE | Transfers the VTR to the DIAG ACTIVE menu. |
| F2 | — | |
| F3 | MENU LAST | Transfers the VTR to the DIAG LAST menu. |
| F4 | — | |
| F5 | WARNING ACTIVATE | Releases mask (cancel) of the warning currently on display. Mask of the warning currently on display in the DIAG MASKED menu is released. The error message for the warning for which mask was released can be displayed on the DIAG ACTIVE menu. |
| F6–F13 | — | |

When there are 2 or more canceled (masked) warnings

- Error messages are displayed from item of highest priority.
- All the messages can be viewed sequentially by operating the cursor and the up/down arrow keys.
- Total number of warnings is displayed.

DIAG LAST menu

When the F3 (MENU LAST) key is pressed on the DIAG ACTIVE or DIAG MASKED menu, the DIAG LAST menu below appears.
 The error messages for the last three warnings are displayed.

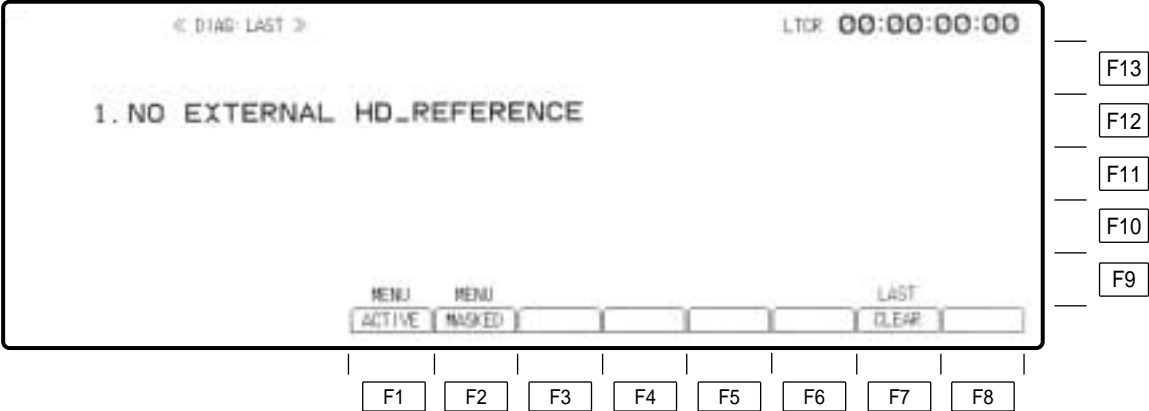

| Key | Key designation | Description |
|--------|-----------------|---|
| F1 | MENU ACTIVE | Transfers the VTR to the DIAG ACTIVE menu. |
| F2 | MENU MASKED | Transfers the VTR to the DIAG MASKED menu. |
| F3–F6 | | |
| F7 | LAST CLEAR | Clears all warnings displayed on the current DIAG LAST menu. All warnings displayed on the current DIAG LAST menu are cleared when the F key is pressed together with the F7 (LAST CLEAR) key. When a new warning is generated, its contents are displayed |
| F8–F13 | — | |

- **When 2 or more warnings have occurred**
 - Error messages are displayed from item of highest priority.
 - All the messages can be viewed sequentially by operating the cursor and the up/down arrow keys.

DIAG error messages

| Message | Error description | On-screen display |
|-------------------------------------|---|-------------------|
| FAN STOP1 | FAN-1 has stopped. It will continue to operate for a while but when the internal temperature rises, its power will be turned off. | FAN STOP |
| FAN STOP2 | FAN-2 has stopped. It will continue to operate for a while but when the internal temperature rises, its power will be turned off. | FAN STOP |
| NO CUE ERASE CURRENT | No erase current is flowing to the CUE erase head. | ERASE ERROR |
| NO TC ERASE CURRENT | No erase current is flowing to the TC erase head. | ERASE ERROR |
| NO FULL ERASE CURRENT | No erase current is flowing to the full erase head. | ERASE ERROR |
| NO CTL ERASE CURRENT | No erase current is flowing to the CTL erase head. | ERASE ERROR |
| VIDEO CONCEAL SW OFF | The VIDEO CONCEAL SW has been set to OFF due to the TEST RF menu setting. | CONCEAL SW OFF |
| INNER ECC SW OFF | The INNER ECC SW has been set to OFF due to the TEST RF menu setting. | ECC SW OFF |
| OUTER VIDEO ECC SW OFF | The OUTER VIDEO ECC SW has been set to OFF due to the TEST RF menu setting. | ECC SW OFF |
| OUTER AUDIO ECC SW OFF | The OUTER AUDIO ECC SW has been set to OFF due to the TEST RF menu setting. | ECC SW OFF |
| AUDIO CONCEAL SW OFF | The AUDIO CONCEAL SW has been set to OFF due to the TEST RF menu setting. | CONCEAL SW OFF |
| T-REE TURNS TOO SLOW | The take-up reel rotation during recording and/or playback is abnormal. | T REER ERROR |
| SERVO UNLOCK | The servo has been disengaged (unlocked). | SERVO UNLOCK |
| CTL NOT DETECTED | The CTL signal cannot be played back. | CTL NOT DET. |
| LOW RF | The RF playback level has dropped. Clean the video heads. (This level is detected only during recording.) | LOW RF |
| AUDIO MUTE | The audio output has been muted. Check the tape playback mode. | AUDIO MUTE |
| CONCEAL A | Errors were corrected in the PCM audio data. Check the tape playback mode. | CONCEAL A |
| CONCEAL V | Errors were corrected in the video data. Check the tape playback mode. | CONCEAL V |
| HIGH ERROR RATE | The error rate has deteriorated. | HIGH ERROR |
| CTL HEAD CLOGGING | The CTL head is clogged. Clean the video heads. | CTL HEAD CLOG |
| LTC HEAD CLOGGING | The LTC head is clogged. Clean the video heads. | LTC HEAD CLOG |
| LOW RF (REC HEAD) | The level of the RF envelope played back from the rotary recording head has dropped. (This level is detected only during playback.) | LOW RF |
| MISTRACK IN OPTIMIZED TRACKING DATA | Tracking optimizing was not completed successfully. | OPT ERROR |

DIAG error messages

| Message | Error description | On-screen display |
|--|---|-------------------|
| WRONG OPTIMIZED TRACKING VALUE | The tracking optimizing operation resulted in a drop in the maximum envelope level by over 25%. Check the tape playback mode. | OPT ERROR |
| SERVO UNLOCKED BEFORE IN POINT | The servo was disengaged (unlocked) before an edit IN point. | OPT ERROR |
| NO EXTERNAL HD REF | The REF signal is not supplied to the HD REF input connector. | HD REF ERROR |
| NO EXTERNAL SD REF | The REF signal is not supplied to the SD REF input connector. | SD REF ERROR |
| NO COLOR BURST IN SD REF | There is no burst signal in the SD REF signal. | SD REF ERROR |
| NO STANDARD SCH-RANGE IN REF | A problem has occurred in SCH of the SD REF signal. | SD REF ERROR |
| NO HD SDI INPUT | There is no HD SDI input. | HD SDI ERROR |
| CRC ERROR IN HD SDI INPUT | A CRC error has been detected from the HD SDI input signal. | HD SDI ERROR |
| NO EMBEDDED AUDIO (CH1/2/3/4) INPUT | Audio signals are not detected in the HD SDI input signal. | HD SDI ERROR |
| NO EMBEDDED AUDIO (CH5/6/7/8) INPUT | Audio signals are not detected in the HD SDI input signal. | HD SDI ERROR |
| AUDIO (CH1/2/3/4) DATA ERROR IN HD SDI INPUT | A transmission error was detected in the audio signals of the HD SDI input signal. | HD SDI ERROR |
| AUDIO (CH5/6/7/8) DATA ERROR IN HD SDI INPUT | A transmission error was detected in the audio signals of the HD SDI input signal. | HD SDI ERROR |
| NO EMBEDDED LTC | The LTC signal is not detected in the HD SDI input signal. | HD SDI ERROR |
| LTC ERROR IN HD SDI INPUT | A transmission error was detected in the LTC signal of the HD SDI input signal. | HD SDI ERROR |
| NO EMBEDDED VITC | The VITC signal is not detected in the HD SDI input signal. | HD SDI ERROR |
| VITC ERROR IN HD SDI INPUT | A transmission error was detected in the VITC signal of the HD SDI input signal. | HD SDI ERROR |
| NO SD SDI INPUT | There is no SD SDI input. | SD SDI ERROR |
| NO EMBEDDED AUDIO (CH1/2/3/4) INPUT | Audio signals are not detected in the SD SDI input signal. | SD SDI ERROR |
| NO EMBEDDED AUDIO (CH5/6/7/8) INPUT | Audio signals are not detected in the SD SDI input signal. | SD SDI ERROR |
| UNMATCH AUDIO RECORDED FORMAT CHECK CASSETTE C BIT | Check the C hole (for identifying the 4-channel/8-channel format) on the cassette. The C hole information and 4- or 8-channel format information recorded on the tape do not match. (When PB.AUTO=ON) | FRMT UNMATCH |
| UNMATCH AUDIO RECORDED FORMAT CHECK SYSTEM FORMAT | Check the VTR system format. The 4- or 8-channel format information recorded on the tape and the 4 or 8 channels set for the VTR system do not match. (When PB.AUTO=OFF) | FRMT UNMATCH |

DIAG error messages

| Message | Error description | On-screen display |
|--|--|-------------------|
| INPUT DIGITAL AUDIO CH1/2 SYNC ERROR CONFIRM INPUT DIGITAL AUDIO | A sync error has occurred in the AES/EBU CH1/2 input signals. Check the input signals. | PCM ERROR |
| INPUT DIGITAL AUDIO CH3/4 SYNC ERROR CONFIRM INPUT DIGITAL AUDIO | A sync error has occurred in the AES/EBU CH3/4 input signals. Check the input signals. | PCM ERROR |
| INPUT DIGITAL AUDIO CH5/6 SYNC ERROR CONFIRM INPUT DIGITAL AUDIO | A sync error has occurred in the AES/EBU CH5/6 input signals. Check the input signals. | PCM ERROR |
| INPUT DIGITAL AUDIO CH7/8 SYNC ERROR CONFIRM INPUT DIGITAL AUDIO | A sync error has occurred in the AES/EBU CH7/8 input signals. Check the input signals. | PCM ERROR |
| INPUT DIGITAL AUDIO CH1/2 CRCC ERROR CONFIRM INPUT DIGITAL AUDIO | A CRCC error has occurred in the AES/EBU or embedded audio CH1/2 input signals. Check the input signals. | PCM ERROR |
| INPUT DIGITAL AUDIO CH3/4 CRCC ERROR CONFIRM INPUT DIGITAL AUDIO | A CRCC error has occurred in the AES/EBU or embedded audio CH3/4 input signals. Check the input signals. | PCM ERROR |
| INPUT DIGITAL AUDIO CH5/6 CRCC ERROR CONFIRM INPUT DIGITAL AUDIO | A CRCC error has occurred in the AES/EBU or embedded audio CH5/6 input signals. Check the input signals. | PCM ERROR |
| INPUT DIGITAL AUDIO CH7/8 CRCC ERROR CONFIRM INPUT DIGITAL AUDIO | A CRCC error has occurred in the AES/EBU or embedded audio CH7/8 input signals. Check the input signals. | PCM ERROR |
| INPUT DIGITAL AUDIO CH1/2 PARITY ERROR CONFIRM INPUT DIGITAL AUDIO | A parity error has occurred in the AES/EBU or embedded audio CH1/2 input signals. Check the input signals. | PCM ERROR |
| INPUT DIGITAL AUDIO CH3/4 PARITY ERROR CONFIRM INPUT DIGITAL AUDIO | A parity error has occurred in the AES/EBU or embedded audio CH3/4 input signals. Check the input signals. | PCM ERROR |
| INPUT DIGITAL AUDIO CH5/6 PARITY ERROR CONFIRM INPUT DIGITAL AUDIO | A parity error has occurred in the AES/EBU or embedded audio CH5/6 input signals. Check the input signals. | PCM ERROR |
| INPUT DIGITAL AUDIO CH7/8 PARITY ERROR CONFIRM INPUT DIGITAL AUDIO | A parity error has occurred in the AES/EBU or embedded audio CH7/8 input signals. Check the input signals. | PCM ERROR |
| RECEIVED INVALID COMMAND FROM RS-422 PORT | An undefined command has been received. | RS-422 ERROR |
| SUM-CHECK ERROR IN RECEIVED COMMAND FROM RS-422 PORT | A sum check error has occurred in the received command. | RS-422 ERROR |
| PARITY ERROR IN RECEIVED COMMAND FROM RS-422 PORT | A parity error has occurred in the received command. | RS-422 ERROR |
| FRAMING ERROR IN RECEIVED COMMAND FROM RS-422 PORT | A framing error has occurred in the received command. | RS-422 ERROR |

DIAG error messages

| Message | Error description | On-screen display |
|---|---|-------------------|
| OVER-RUN ERROR IN RECEIVED COMMAND FROM RS-422 PORT | An overrun error has occurred in the received command. | RS-422 ERROR |
| RS-422 COMMUNICATION STOP BY TIME OUT | A timeout error has occurred. | RS-422 ERROR |
| RECEIVED INVALID COMMAND FROM RS-232C PORT | An undefined command has been received. | RS-232C ERROR |
| SUM-CHECK ERROR IN RECEIVED COMMAND FROM RS-232C PORT | A sum check error has occurred in the received command. | RS-232C ERROR |
| PARITY ERROR IN RECEIVED COMMAND FROM RS-232C PORT | A parity error has occurred in the received command. | RS-232C ERROR |
| FRAMING ERROR IN RECEIVED COMMAND FROM RS-232C PORT | A framing error has occurred in the received command. | RS-232C ERROR |
| OVER-RUN ERROR IN RECEIVED COMMAND FROM RS-232C PORT | An overrun error has occurred in the received command. | RS-232C ERROR |
| RS-232C COMMUNICATION STOP BY TIME OUT | A timeout error has occurred. | RS-232C ERROR |
| RECEIVED INVALID COMMAND FROM VA_CONT PORT | An undefined command has been received. | VA-CONT ERROR |
| SUM-CHECK ERROR IN RECEIVED COMMAND FROM VA_CONT PORT | A sum check error has occurred in the received command. | VA-CONT ERROR |
| PARITY ERROR IN RECEIVED COMMAND FROM VA_CONT PORT | A parity error has occurred in the received command. | VA-CONT ERROR |
| FRAMING ERROR IN RECEIVED COMMAND FROM VA_CONT PORT | A framing error has occurred in the received command. | VA-CONT ERROR |
| OVER-RUN ERROR IN RECEIVED COMMAND FROM VA_CONT PORT | An overrun error has occurred in the received command. | VA-CONT ERROR |
| EXT LTC NOT READ | There is a problem with the EXT TC input. | TC ERROR |
| EXT VITC NOT READ | There is a problem with the EXT VITC input. | TC ERROR |
| LTC IN TAPE NOT READ | The LTC signal is not played back. | TC ERROR |
| IC CARD LOW BATTERY | The IC card battery has a low remaining charge. Replace the card. | CARD LOW BATT |

AUTO OFF error messages

If a problem has occurred and the VTR cannot continue operating or the mechanism or tape may be damaged by continued operation, the AUTO OFF lamp on the VTR's front panel come on, the buzzer sounds, and an error message appears on the screen. In this situation, stop operating the VTR, and proceed to fix the problem.

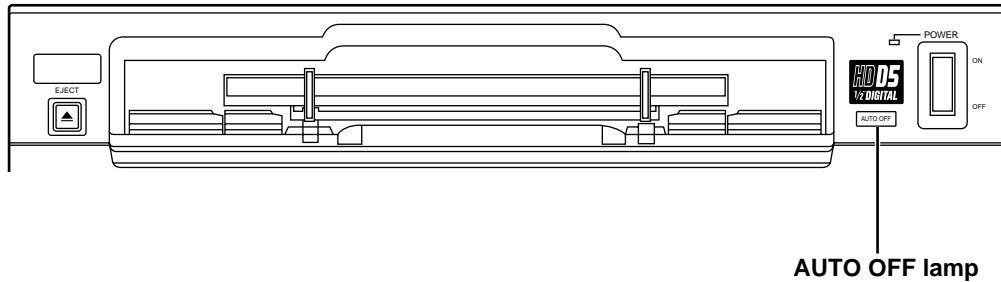

AUTO OFF
CASSETTE UNLOAD FAIL
POWER OFF

- With the exception of the DEW error message, the original screen will not be restored unless the power is turned off and then back on again.

If the error persists even after the power has been turned off and then back on again, the problem is serious, and the VTR will need to be repaired or some of its parts replaced. Immediately turn off the power, remove the power plug from the power outlet, and contact your dealer. Bear in mind that continued operation may exacerbate the existing problem and/or cause other unforeseen problems.

AUTO OFF occurs mainly when the tape transport system is experiencing problems. When AUTO OFF has occurred, open the VTR's top panel, check that the tape in use has been properly installed in the transport system, and then turn on the power. If the tape in use has become disengaged from the transport system, contact your dealer.

AUTO OFF error messages

| Message | Error description | On-screen display |
|---------------------------------|--|-------------------|
| CPU TAPE HANDLE TROUBLE | The CPU is not working properly due to an error in the interrupt processing, etc. | SYSCON ERROR |
| CPU (SERVO SYS) COMM. TROUBLE | A problem has occurred in communication between the servo microcomputer and system control microcomputer. | SERVO ERROR |
| CASSETTE PHOTO SENSOR TROUBLE | A problem with the LED has been detected. | MECHA ERROR |
| DETECTION SWITCH FAIL (A) | There is a problem with the cassette's 3-stage switch (A) (on the cylinder side). | MECHA ERROR |
| DETECTION SWITCH FAIL (B) | There is a problem with the cassette's 3-stage switch (B) (middle position). | MECHA ERROR |
| DETECTION SWITCH FAIL (C) | There is a problem with the cassette's 3-stage switch (C) (on the cassette insertion slot side). | MECHA ERROR |
| ROTATE-RANGE OVER | A problem with the cylinder's rotation has been detected. | SERVO ERROR |
| CAPSTAN NOT ROTATE | A problem with the capstan's rotation has been detected. | SERVO ERROR |
| TAPE TENSION ERROR | A tape tension error has been detected. (Pinch roller ON status) Check the tape transport system. | SERVO ERROR |
| TAPE TENSION OVER-RANGE IN SHTL | A tape tension error has been detected. (Reel drive status with pinch roller OFF) Check the tape transport system. | SERVO ERROR |
| REEL DIRECTION UNMUTCH | A discrepancy in the rotational directions of the supply and take-up reels has been detected. Check the tape transport system. | SERVO ERROR |
| WIND-UP REEL NOT ROTATE | Defective rotation of the take-up reel has been detected. (During capstan drive) Check the tape transport system. | SERVO ERROR |
| NO S-REEL FG PULSE | Trouble with the rotation of the supply reel has been detected. | SERVO ERROR |
| NO T-REEL FG PULSE | Trouble with the rotation of the take-up reel has been detected. | SERVO ERROR |
| CASSETTE UNLOAD FAIL | A problem with the cassette "up" operation has occurred. Check the tape transport system. | MECHA ERROR |
| SUB UNLACING FAIL | A problem with the sub-unloading operation has occurred. Check the tape transport system. | MECHA ERROR |
| MAIN UNLACING FAIL | A problem with the main unloading operation has occurred. Check the tape transport system. | MECHA ERROR |
| DEW | The formation of condensation has been detected. Refrain from inserting a cassette since this condition may cause the tape to adhere to the inside parts, etc., thereby damaging it. | MECHA ERROR |

SYSTEM error messages

When a problem has occurred in the VTR and its operation can no longer be guaranteed, the system error lamp comes on, the buzzer sounds, and an error message appears on the screen.

In this situation, stop operating the VTR immediately, and proceed to fix the trouble.

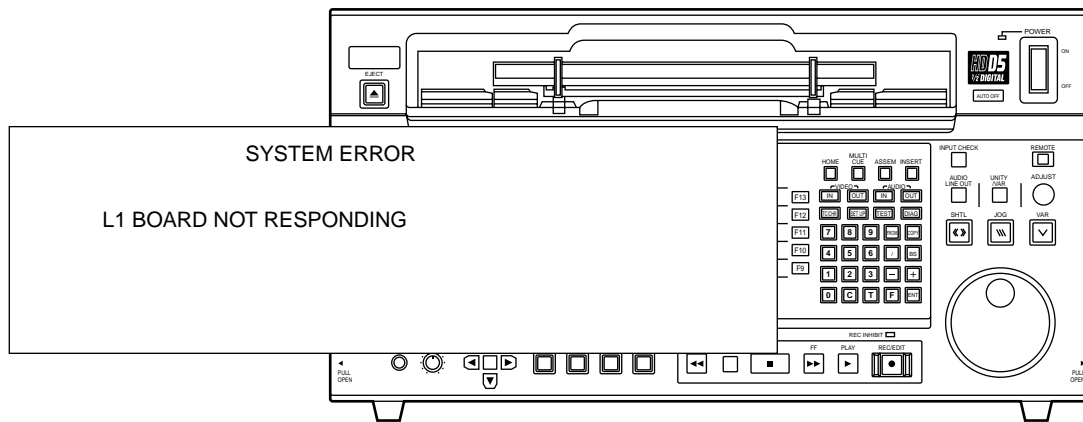

- With system errors, the original screen will be restored when the power switch is turned off and the cause of the error is eliminated.

SYSTEM error messages

| Message | Error description | On-screen display |
|-------------------------|---|-------------------|
| AV NOT RESPONDING | The AV microcomputer is not working properly. The reference signals from the S5 printed circuit board may not be the prescribed ones or some similar kind of problem is to blame. | SYSTEM ERROR |
| SYSCON NOT RESPONDING | A problem has occurred in communication between the system control microcomputer and front microcomputer. | SYSTEM ERROR |
| S2 BOARD NOT RESPONDING | The S2 printed circuit board has been removed. | SYSTEM ERROR |
| S3 BOARD NOT RESPONDING | The S3 printed circuit board has been removed. | SYSTEM ERROR |
| S4 BOARD NOT RESPONDING | The circuitry on the S4 PCB is not operating properly. | SYSTEM ERROR |
| S5 BOARD NOT RESPONDING | The circuitry on the S5 PCB is not operating properly. | SYSTEM ERROR |
| L1 BOARD NOT RESPONDING | The circuitry on the L1 PCB is not operating properly. | SYSTEM ERROR |
| L2 BOARD NOT RESPONDING | The circuitry on the L2 PCB is not operating properly. | SYSTEM ERROR |
| CASSETTE LOAD FAIL | A problem has occurred during the cassette "down" operation. | MECHA ERROR |
| SUB LACING FAIL | A problem was detected during the sub-loading operation, and the cassette was ejected. Check the tape transport system. | MECHA ERROR |
| MAIN LACING FAIL | A problem was detected during the main loading operation, and the cassette was ejected. Check the tape transport system. | MECHA ERROR |
| HUB POSITION | The reel hub position does not match the cassette size. The cassette was ejected as a result. | MECHA ERROR |

Operation messages

In the majority of cases, when a mistake has been made in operating a button or key during automatic editing, a message appears at the bottom right of the screen (above the tape speed display) telling the user how to proceed with operation.

- The message is automatically cleared after it has been displayed for several seconds.

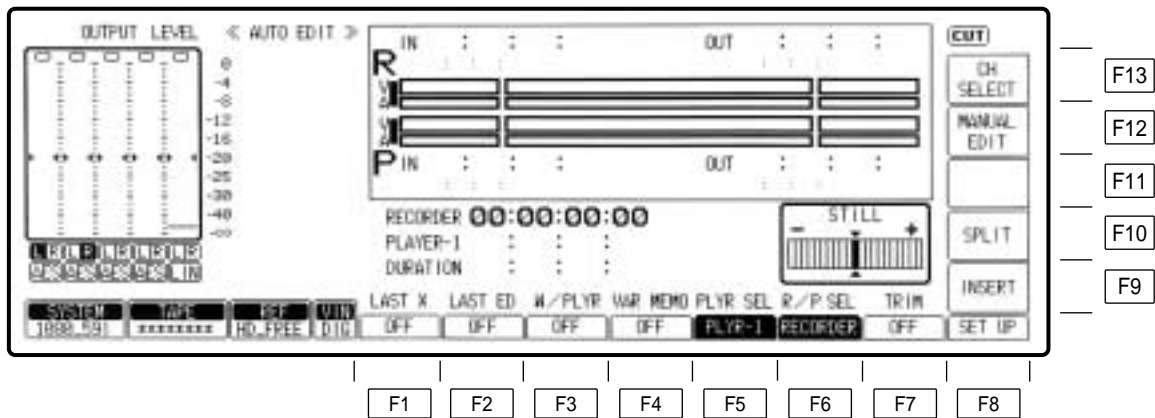

Operation messages (in AUTO EDIT mode)

| No. | Message | Description of error/problem |
|-----|----------------------|--|
| 350 | NO CASSETTE | A cassette tape has not been inserted. |
| 351 | NO PRESET | The editing channel has not been selected in the editing mode or during insert editing. |
| 352 | NO IN POINT | The edit point data required for editing has not been entered. |
| 353 | NO PLY' R MODE | The mode in which the player is to be controlled has not been established. Set it correctly on the INSERT (or ASSEMBLE) AUTO EDIT menu. |
| 354 | NOT REC' R MODE | The mode in which the recorder is to be controlled has not been established. Set it correctly on the INSERT (or ASSEMBLE) AUTO EDIT menu. |
| 355 | NEGATIVE DURATION | The time data of the edit OUT point is ahead of the time data of the edit IN point. |
| 356 | INVALID DATA | Illegal or invalid data has been input. |
| 357 | PLAYER LOCAL | The connected player is in the LOCAL mode. |
| 359 | REC INHIBITED | An attempt has been made to execute automatic editing while the recording inhibit mode is set. Select the HOME menu setting and operate the recording inhibit pins on the cassette tape to release the REC INHIBIT mode. |
| 360 | W/PLAYER NOT SET | A mode in which the player can be used has not been established. Check the F1 (MODE) key setting on the INSERT (or ASSEMBLE) AUTO EDIT SET UP menu. |
| 361 | BOT | The tape is at its end. |
| 362 | EOT | The tape is at its start. |
| 363 | SHIFT TC FOR CF EDIT | The TC value used in the CF lock mode is incorrect |

Screen saver function

This function is designed to prolong the service life of the VTR's large display screen.

The screen's life may be shortened when the screen continuously displays menu screens on which no movement is occurring.

Consequently, when the same menu screen on which no movement occurs is displayed continuously on the display screen for 5 or more minutes, it is automatically replaced with the screen saver screen shown below.



The logo displayed moves around the screen.

<Notes>

- The screen saver function is activated only when a menu screen on which absolutely no movement occurs has been displayed continuously for 5 or more minutes. If a function key is pressed at some point, it will not be activated unless another 5 minutes have elapsed from the moment when the key was pressed.
- Neither will the screen saver function be activated when the time code value on a menu screen has changed during recording, playback, etc. even if nothing else has changed.

Panasonic

PANASONIC BROADCAST & TELEVISION SYSTEMS COMPANY
UNIT COMPANY OF MATSUSHITA ELECTRIC CORPORATION OF AMERICA

Executive Office:

One Panasonic Way 4E-7, Secaucus, NJ 07094 (201) 348-7000

EASTERN ZONE:

One Panasonic Way 4E-7, Secaucus, NJ 07094 (201) 348-7621

Southeast Region:

1225 Northbrook Parkway, Ste 1-160, Suwanee, GA 30024 (770) 338-6835

Central Region:

1707 N Randall Road E1-C-1, Elgin, IL 60123 (847) 468-5200

WESTERN ZONE:

3330 Cahuenga Blvd W., Los Angeles, CA 90068 (323) 436-3500

Government Marketing Department:

52 West Gude Drive, Rockville, MD 20850 (301) 738-3840

Broadcast PARTS INFORMATION & ORDERING:

9:00 a.m.–5:00 p.m. (EST) (800) 334-4881/24 Hr. Fax (800) 334-4880

Emergency after hour parts orders (800) 334-4881

TECHNICAL SUPPORT:

Emergency 24 Hour Service (800) 222-0741

Panasonic Canada Inc.

5770 Ambler Drive, Mississauga, Ontario L4W 2T3 (905) 624-5010

Panasonic de Mexico S.A. de C.V.

Av angel Urraza Num. 1209 Col. de Valle 03100 Mexico, D.F. (52) 1 951 2127

Panasonic Sales Company

Division of Matsushita Electric of Puerto Rico Inc.

San Gabriel Industrial Park, 65th Infantry Ave., Km. 9.5, Carolina, Puerto Rico 00630 (787) 750-4300

Panasonic Broadcast Europe

Panasonic Broadcast Europe Ltd.

West Forest Gate, Wellington Road, Wokingham, Berkshire RG40 2AQ U.K. Tel: 0118 902 9200

Panasonic Broadcast Europe GmbH

Hagenauer Str. 43, 65203 Wiesbaden-Biebrich Deutschland Tel: 49-611-1816-0